

# Automatic Cleaning System Design to Increase PV Panel Output Power

*by* Muhammad Zulfahmi

---

**Submission date:** 17-Apr-2023 04:01PM (UTC+0800)

**Submission ID:** 2067014739

**File name:** 5\_Automatic\_Cleaning\_System\_Design\_to\_Increase.pdf (726.31K)

**Word count:** 3976

**Character count:** 20631

## Automatic Cleaning System Design to Increase PV Panel Output Power

Muhammad Zulfahmi<sup>1,2</sup>, RD. Kusumanto<sup>3</sup>, Yohandri Bow<sup>4</sup>

<sup>1</sup>Applied Master of Renewable Energy Engineering, Politeknik Negeri Sriwijaya, Palembang, Indonesia

<sup>2</sup>Internal Control Department, PT Bukit Asam, Tbk Tanjung Enim, Indonesia

<sup>3</sup>Electrical Engineering Department, Politeknik Negeri Sriwijaya, Palembang, Indonesia

<sup>4</sup>Chemical Engineering Department, Energy Engineering Study Program, Politeknik Negeri Sriwijaya, Palembang, Indonesia

### Article Info

#### Article history:

Received July 11, 2021

Revised August 10, 2021

Accepted August 20, 2021

#### Keywords:

Cleaning system

PV panel

Water sprayer

### ABSTRACT

The existence of the Township Housing, which is currently near the coal mine site, precisely in Tanjung Enim, South Sumatra, with a relatively open area (41 Ha) and a relatively high elevation of approximately 100 meters above the sea level, has the potential to be installed with PV panels as a solar power plant. Installation of PV panels in residential areas close to coal mining activities has the potential to indirectly generate a lot of mine dust which can reduce the amount of light received by the PV panels, which in turn can affect the output power of the PV panels. The purpose of this study is to analyze the use of an automatic cleaning system to increase the output power of PV panels by comparing the output power of PV panels produced between PV panels with an automatic cleaning system in the form of a water sprayer with PV panels that are not equipped with a water sprayer (standard PV installation). The use of an automatic cleaning system shows an increase in the average output power of 44.56 Watt. The difference between Isc PV water sprayer and normal PV is 0.5513 A. Iload measurement on PV water sprayer is 0.1973 A higher than normal PV, while for VOC PV panel water sprayer is smaller than normal PV is about 0.45 V. For PV water sprayer Vload is 0.431 V is more significant than normal PV panels. Meanwhile, for the generated load power or Pload, the PV water sprayer is 9.47 watts higher than normal PV. From all these values, the average efficiency produced by PV water sprayer is 1.81% greater than the efficiency produced by normal PV. This study shows that PV using a water sprayer produces an average output power of 44.56 watts

This is an open access article under the [CC BY-SA](https://creativecommons.org/licenses/by/4.0/) license.



### Corresponding Author:

RD. Kusumanto

Electrical Engineering Department

Politeknik Negeri Sriwijaya

Palembang, South Sumatra, Indonesia

Email: [rd.kusumanto@polsri.ac.id](mailto:rd.kusumanto@polsri.ac.id)

### 1. INTRODUCTION

The use of solar power plants has begun to be widely used in Indonesia, such as street and park lighting, traffic lights, and so on. However, compared to other developed countries, Indonesia is still very far behind. However, until now, many researchers, scientists, and Indonesian people continue to develop, research, and optimize the use and utilization of solar power plants [6].

The government, through the Ministry of Energy and Mineral Resources (ESDM) has encouraged the business world to implement the use of new and renewable energy, including the installation of solar

<sup>1</sup>  
DOI: <https://doi.org/10.53893/ijrvocas.v1i2.48>

panels for places or locations that have not been reached by the PLN electricity network, namely remote villages or island areas [1].

Especially in mining locations that are identical to locations far from urban areas, applying new and renewable energy sources, especially solar power plants, is possible to be applied. Apart from the large area, the mining area is an opening area where the potential for sunlight is relatively free on the surface. However, the mining activities carried out produce a lot of mining dust, reducing the amount of light entering the PV panels. In recent years, there has been an increase in projects for the installation and operation of renewable energy generation systems at abandoned mine sites (post-mine reclamation) to revitalize ex-mining land [6].

Recently, global mining companies and international environmental protection organizations have identified the application of solar energy as a solution to address all the demands of mining areas to reduce environmental impacts and re-establishment of post-mining areas into green energy areas. As a result, PV systems are being installed globally at both operating and abandoned mining sites. One of the top copper-producing countries, Chile, designed the 1MW Calama 3 solar power plant project connected to the grid near the world's largest copper mine, the Chuquicamata copper mine, to meet the mine's electricity needs. As a result, Chile experienced an annual reduction in GHG emissions of 1,600 metric tons. In Western Australia installed a 10.6 MW PV generating system at the copper-gold mine, the Degussa mine. In this area, mining operations previously relied on fossil fuels, and the installation of a PV system reduced Australia's total emissions by 12,000 metric tons per year. Shanta Gold, an East African gold mining company in Tanzania, deployed a 63 kWp solar power plant in the vicinity of the New Luika gold mine in 2014. Following the success of the initial phase, the addition of seven new PV mini-grid projects was installed in the next three years, which is equivalent to a reduction in CO<sub>2</sub> annual amount of 660 tons [7].

Germany's largest PV power plant (166 MW) is installed at Meuro, an abandoned minefield near Leipzig. In Korea, a small-scale (85 kW) photovoltaic (PV) system was installed at the passive acid mine drainage (AMD) treatment facility at the Hambaek coal mine (Jeongseon-gun, Gangwon-do) and another 80 kW PV system at the AMD physicochemical treatment facility in Hamtae coal mine (Taebaek-si, Gangwon-do) [6].

In Indonesia itself, at this time, considering the reclamation area of former coal mines supervised by the Government for the reclamation program, the relatively large land area of 6,017 hectares has the potential to become a PLTS development area, although it still requires further study. This is related to the challenges in its implementation, including the allocation in the RUPTL of PT PLN (Persero), which is still limited for PLTS development, the status of the mining area land, and the manager price and area of land used. Currently, eight mining companies have proposed the use of ex-mining land for PLTS. These companies include PT Trubaindo Coal Mining, PT Indominco Mandiri, PT Multi Harapan Utama, PT Bukit Asam Tbk., PT Timah Tbk., PT Adaro Indonesia, PT Borneo Indobara, and PT Berau Coal. [6].

The factors that affect the optimal performance of a solar panel are the influence of temperature, shading effect, dust, and the material of the solar cell itself. One example is if the cover glass, which is the outermost layer of a solar panel, is covered with dust or other barrier materials, then it blocks the entry of the intensity of sunlight and dramatically affects the process of the photoelectric effect on the solar cell panel so that the electrical energy produced is not optimal, which called the shading effect. This paper was created to obtain data on the characteristics of PV panels installed in the employee housing area near an open-pit mine site that produces a lot of mining dust. This study compares the output produced by PV panels equipped with an automatic cleaning system in a water sprayer and PV panels under normal conditions.

## 2. RESEARCH METHOD

This study analyzes the characteristics of PV panels installed in residential areas that are relatively close to open pit coal mine activities that produce a lot of mining dust. One of the PV panels will be equipped with an automatic water cleaning system (water sprayer) and the other will not (normal). The electricity production and efficiency of the two installed PV panels will be compared to determine their characteristics.

### 2.1. Potential Installation of PV Panels in Township Housing Near an Open-Pit Coal Mine

This research was carried out in the Township Housing, which is within 6.8 km from the open-pit coal mine activity, which allows the amount of concentrated mining dust to reduce the amount of sunlight entering the PV panel.

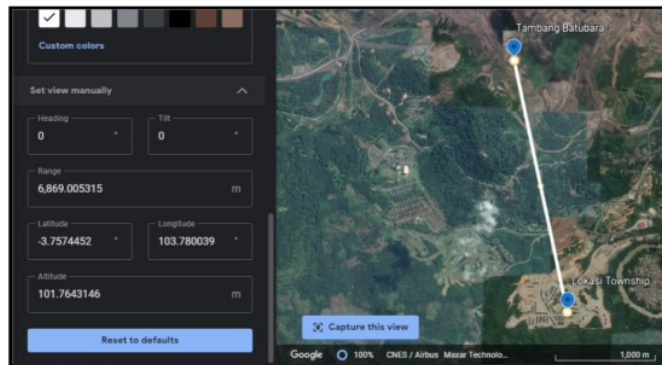

Figure 1. Satellite photo of the open-pit coal mine site

Figure 1 illustrates the open-pit coal mine location. The Township housing area is approximately 41 hectares open with a high enough elevation, which has the potential to be installed with PV panels as a solar power plant. However, open-pit mining activities currently produce a lot of concentrated mining dust and can reduce the amount of light received by the PV panels

## 2.2. Research Design

This research design uses two monocrystalline 120 WP (W-peak) PV panels equipped with a water sprayer automatic cleaning system and one without a water sprayer at the Tanah Putih Township Housing location. The output condition of the PV panel is connected to a 17 Watt 12 VDC water pump as a load. The arrangement of the circuit and the installation of the measuring instrument is shown in Fig 2.

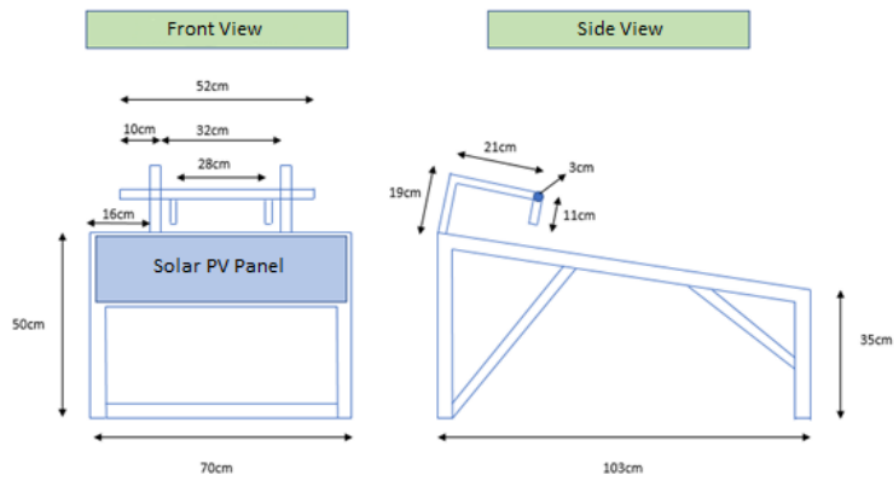

Figure 2. PV panel mount rack structure

Figure 3 shows the dimensions of the frame for the PV panel position. The difference between the two PV panel installations is that one PV panel is equipped with an automatic water cleaning system in the form of a water sprayer, and the other is a normal PV panel.

This research began from March 1 to March 30, 2021 in Tanjung Enim, Muara Enim Regency, South Sumatra. PTBA Tanah Putih Township Housing is located at 3°46'20"S, 103°46'49"E, about 190 km from Palembang, the capital city of South Sumatra province. The measurement data is recorded every hour from 07.00 WIB to 17.00 WIB every day. The PV panel temperature with the highest water spray was 65.4 °C, the highest normal PV was 65.1°C, while the highest ambient temperature was recorded at 33.6 °C.



Figure 3. Circuit and installation of measuring tools

**3. RESULTS AND DISCUSSION**

This research focused on the results of the power output characteristics of PV panels paired with a water sprayer to see their potential in the future. As a comparison, measurements are also made on normal PV panels at the Tanah Putih Township Housing location. Figure 4 shows a comparison graph between irradiance, ambient temperature, PV temperature, and load power generated when the weather conditions are quite sunny on March 3, 2021. The graph shows that the increase in irradiance is followed by an increase in PV temperature and increased load power. The temperature of the PV water sprayer is 15.78°C lower than normal PV, while the load power produced by the PV water sprayer is higher than normal PV with an average difference of ±17 Watt. Maximum power occurs from 09.00 to 14.00 GMT+7.

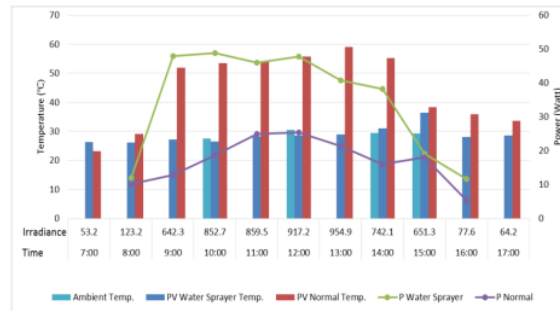

Figure 4. Comparison of power production to temperature March 3, 2021

As for changing weather, electricity production or load power generated by PV panels can be shown in Figure 5, where the sample data used is March 20, 2021. The graph shows that weather significantly affects electricity production generated from both installed PV, where a decrease follows the decrease in irradiance during cloudy weather in electricity production and a decrease in PV temperature. The difference in average power produced between PV water sprayer and normal PV is ± 7 Watt.

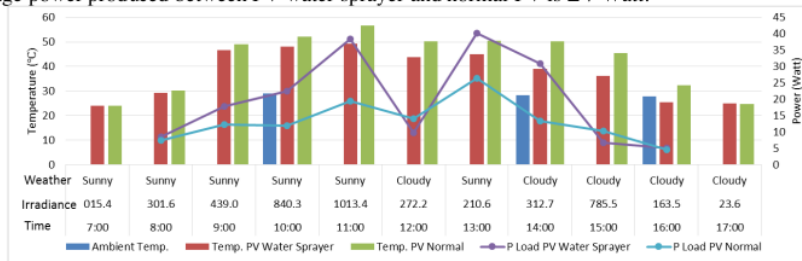

Figure 5. Comparison of load power production to changes in temperature and weather on March 20, 2021.



Furthermore, to illustrate the influence of weather on electricity production, it will be shown in Figure 6, where the load power data on March 2, 2021 when the weather is sunny, will be compared with data on March 17, 2021 when it is cloudy and rainy all day and March 20, 2021 when it is cloudy or cloudy. When the weather is sunny all day (2 March 2021), solar radiation received by PV panels continues to increase every hour, followed by an increase in electricity production until its peak at 09.00 to 15.00 GMT+7, and electricity production continues to decrease along with a decrease in solar radiation until the afternoon. The electricity generated on March 17, 2021 and March 20, 2021 is very inefficient due to cloudy weather and rain for most of the day.

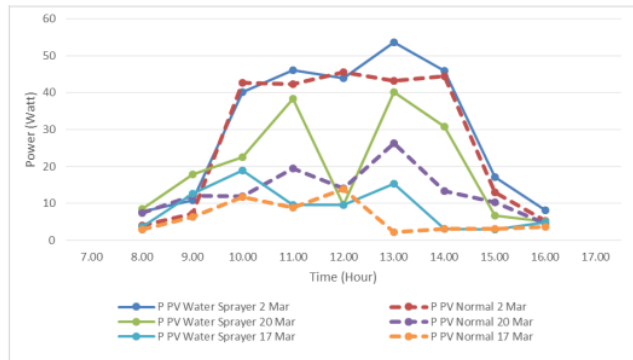

Figure 6. Power generated on March 2, March 17 and March 20, 2021

Figure 7 will show the effect of sunlight intensity (irradiance) on the maximum  $I_{sc}$  (short-circuit current) value of the water sprayer PV and normal PV, as well as the maximum  $I_{load}$  (load current) of the two PVs when connected to a DC water pump load during the research time. Furthermore, Figure 8. shows a comparison between the  $V_{oc}$  values of the two installed PV panels and the difference between the  $V_{load}$  values measured while being loaded with a DC water pump on the two PV panels.  $I_{sc}$  is the maximum current generated by the panel when the voltage is zero, and  $V_{oc}$  is the maximum voltage generated by the PV panel when the current is zero. These two parameters are the critical components for the formation of the I-V curve.

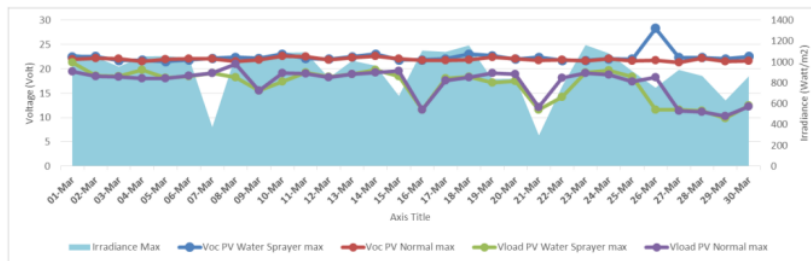

Figure 8. Maximum  $V_{oc}$  and  $V_{load}$  results from watersprayer PV and normal PV

Then in Figure 9 below shows the comparison of the power generated per day from each installed PV panel. The power generated is very dependent on the size of the solar radiation (irradiance) captured by the PV panel. From Figure 9, it is clear that the higher the irradiance, the higher the power generated, and vice versa. Fairly sunny weather occurred on March 2, 3, 8, and 19, 2021, where the average irradiance was relatively high on those dates and was proportional to the power generated. On March 2, 2021 the maximum irradiance that occurs is 528.44 W/m<sup>2</sup>, on March 3, 2021 it is 539.83 W/m<sup>2</sup>, on March 8, 2021 it is 487.9 W/m<sup>2</sup>, on March 19, 2021 it is 348.5 W/m<sup>2</sup>. Of the four dates above, the highest total load power was recorded on March 3 and 19, 2021, namely 312.4 Watt and 334.9 Watt.

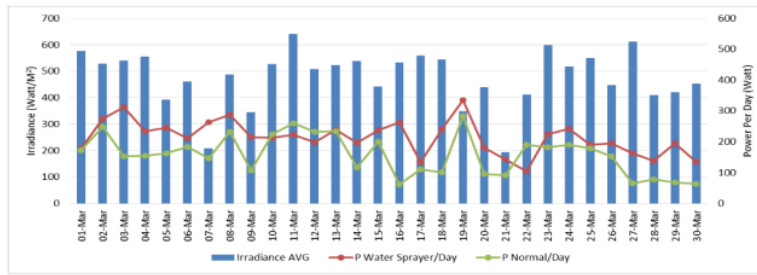

Figure 9. Comparison of the resulting load power per day by both PV panels

Figure 10 shows the maximum irradiance measured daily during the study compared to the maximum daily load generated by the two installed PV panels. From the measurement results, the maximum load power produced by the PV water spray is on average 9.47 watts higher than the average maximum load power produced by normal PV. The highest load power was recorded on March 8, 2021, which was 58.3 watts.

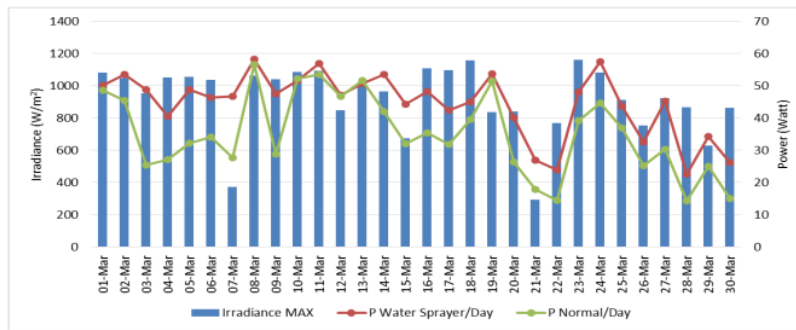

Figure 10. Effect of irradiance on load power (P watersprayer and P normal)

Figure 11 shows the efficiency of the PV panels that are installed with a water sprayer automatic cleaning system and normal PV panels in the Township housing. This efficiency is measured based on the ratio of the input power of the  $P_{in}$  and the power of the load (power generated), where the  $P_{in}$  is calculated based on the irradiance received measured multiplied by the area/cross-section of the PV panel. The average efficiency of PV panels using a water sprayer is 1.81% higher than the efficiency of normal PV panels.

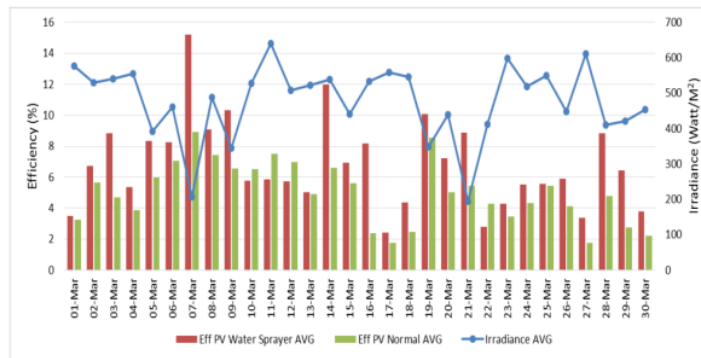

Figure 11. Comparison of Efficiency of PV water sprayer and normal PV

The higher efficiency value obtained compared to normal PV proves that the design of an automatic cleaning system in the form of a water sprayer can increase the output power of the PV panel up to 1.81%. The difference in PV temperature between PV water sprayer and normal PV shows that in the PV water sprayer during the panel cleaning process, the output power on the PV panel is greater and maximum, this also causes the efficiency value in the middle to the end of the month to tend to decrease because the research takes place during the transition season of the rainy season.

#### 4. CONCLUSION

The research results that have been carried out in this study make it possible to install a water sprayer on PV panels at the Tanah Putih Township housing location PTBA Tanjung Enim, Muara Enim Regency South Sumatra to increase the output power of the PV panels. PV panels installed with a water sprayer produce better electrical power and efficiency than normal PV panels. In addition, the difference between the  $I_{sc}$  PV panel water sprayer and the normal PV panel is 0.5513 A. Iload measurement of the PV panel water sprayer is 0.1973 A, which is higher than normal PV panel water sprayer. As for the  $V_{oc}$  PV panel water sprayer is smaller than normal PV panels around 0.45 V. Moreover, the  $V_{load}$  PV water sprayer is 0.431 V larger than normal PV. Meanwhile, for the generated load power or  $P_{load}$ , the PV water sprayer is 9.47 Watts greater than normal PV. From all these values, the average efficiency produced by PV water sprayer is 1.81% greater than the efficiency produced by normal PV.

#### ACKNOWLEDGEMENTS

The author would like to thank Advisors I and II, my beloved wife and children, who have participated in this research. The author also expresses his gratitude to all those who have helped in providing suggestions and input.



#### REFERENCES

- [1] Dewan Energi Nasional " Outlook Energi Indonesia 2019" Jakarta, September 2019. Idzani Muttaqin., 2016, Analisa Rancangan Sel Surya dengan Kapasitas 50 Watt untuk Penerangan Parkiran UNISKA, *Jurnal Teknik Mesin UNISKA Vol.1 No.2*.
- [2] Jinyoung Song and Yosoon Choi, " Analysis of the Potential for Use of Floating Photovoltaic Systems on Mine Pit Lakes: Case Study at the Ssangyong Open-Pit Limestone Mine in Korea", Department of Energy Resources Engineering, Pukyong National University, Busan 608-737, Korea, MDPI, Published: 10 February 2016.
- [3] Ovi Irawan, Yohandri Bow, RD Kusumanto, 2021, Simulation and Performance Test giromill Type Wind Turbine, International Journal of Research in Vocational Studies (IJRVOCAS), 2.
- [4] Mokhinabonu Mardonova and Yosoon Choi, " Assessment of Photovoltaic Potential of Mining Sites in Uzbekistan", Department of Energy Resources Engineering, Pukyong National University, Busan 48513, Korea, MDPI, Published: 26 May 2019.
- [5] LUCAS-NÜLLE GmbH, Renewable energy - Photovoltaiks. 2002.
- [6] R. Ploetz, R. Rusdianasari, E. Eviliana, "Renewable Energy: Advantages and Disadvantages," Proceeding Forum in Research, Science, and Technology (FIRST), 2016. Kumiawan A, Taqwa A, Bow Y. 2019. PLC Application as an Automatic Transfer Switch for on-grid PV System; Case Study Jakabaring Solar Power Plant Palembang J. Phys.: Conf. Ser. 1167 012026
- [7] R. B. Yuliandi, T. Dewi, and Rusdianasari, "Comparison of Blade Dimension Design of a Vertical Wind Turbine Applied in Low Wind Speed," In proceeding of E3S Web of Conferences EDP Sciences, Vol. 68, p. 01001, 2018.
- [8] IRENA, Renewable Energy Prospects: Indonesia, a REmap analysis, International Renewable Energy Agency (IRENA), Abu Dhabi, 2017, www.irena.org/remap.
- [9] Mirdiansyah, A. Taqwa, Y. Bow. Monitoring Depth of Discharge of a Valve Regulated Lead Acid Battery in a Standalone PV System. Proceedings of the 4th Forum in Research, Science, and Technology (FIRST-T1-T2-2020), 2021
- [10] H.A. Harahap, T. Dewi, and Rusdianasari, "Automatic Cooling System for Efficiency and Output Enhancement of a PV System Application in Palembang, Indonesia," in 2nd Forum in Research, Science, and Technology, IOP Conf. Series: Journal of Physics: Conf. Series 1167 012027, 2019. doi:10.1088/1742-6596/1167/1/012027.
- [11] B. Junianto, T. Dewi, and C. R. Sitompul, "Development and Feasibility Analysis of Floating Solar Panel Application in Palembang, South Sumatra Journal of Physics: Conf. Series 3rd Forum in Research, Science, and Technology Palembang, Indonesia, 2020.
- [12] Y Bow, T Dewi, A Taqwa, Rusdianasari, Zulkarnain, Power Transistor 2N3055 as a Solar Cell Device, International Conference on Electrical Engineering and Computer Science (ICECOS), IEEE, 2018
- [13] A. A. Sasmano, T. Dewi, and Rusdianasari, "Eligibility Study on Floating Solar Panel Installation over Brackish Water in Sungsang, South Sumatra," EMITTER International Journal of Engineering Technology, Vol. 8, No. 1, 2020.
- [14] K. Junaedi, T. Dewi, and M. S. Yusi, "The Potential Overview of PV System Installation at the Quarry Open Pit Automatic Cleaning System Design to Increase PV Panel Output Power



- Mine PT. Bukit Asam, Tbk Tanjung Enim," Kinetik: Game Technology, Information System, Computer Network, Computing, Electronics, and Control, Vol. 6, No. 1, pp. 41-50, 2021. <https://doi.org/10.22219/kinetik.v6i1.1148>.
- [15] Sarwono, T. Dewi, and RD Kusumanto, "Geographical Location Effects on PV Panel Output - Comparison Between Highland and Lowland Installation in South Sumatra, Indonesia," Technology Reports of Kansai University, Vol. 63, No. 02, pp. 7229-7243, 2021. ISSN: 04532198.
- [16] A. Taqwa, T. Dewi, A. A. Sasmanto, Rusdianasari, and Y. Bow, "Feasibility Study and Design of IoT-based Monitoring for Remote PV System," Technology Reports of Kansai University, Vol. 63, No. 01, pp. 6933-6944, 2021. ISSN: 04532198.
- [17] B. Hanafiah, A. Taqwa, RD Kusumanto, and T. Dewi, "Synchronization and Application of IoT for on Grid Hybrid PV-Wind System," In Proceeding of 2018 International Conference on Applied Science and Technology (iCAST) IEEE, p. 617-621, 2018.
- [18] T. Dewi, P. Risma, Y. Oktarina, A. Taqwa, Rusdianasari, and H. Renaldi, "Experimental analysis on solar powered mobile robot as the prototype for environmentally friendly automated transportation," in Proceeding of Journal of Physics: Conference Series, International Conference on Applied Science and Technology (iCAST on Engineering Science) Bali, Indonesia, Vol. 1450, 2020.
- [19] I. N. Zhafarina, T. Dewi, and Rusdianasari, "Analysis of Maximum Power Reduction Efficiency of Photovoltaic System at PT. Pertamina (Persero) RU III Plaju," VOLT: Jurnal Ilmiah Pendidikan Teknik Elektro, Vol. 3, No 1, pp.19-25, 2018.
- [20] I. Arisetyadhi, T. Dewi, and RD Kusumanto, "Experimental Study on The Effect of Arches Setting on Semi-Flexible Monocrystalline Solar Panels," Kinetik: Game Technology, Information System, Computer Network, Computing, Electronics, and Control. KINETIK Vol. 5, No 2, pp. 111-118, 2020.
- [21] P. P. Putra, T. Dewi, Rusdianasari, "MPPT Implementation for Solar-powered Watering System Performance Enhancement," Technology Reports of Kansai University, Vol. 63, No. 01, pp. 6919-6931, 2021. ISSN: 04532198.
- [22] A. Edward, T. Dewi, and Rusdianasari, "The effectiveness of Solar Tracker Use on Solar Panels to The Output of The Generated Electricity Power IOP Conference Series," in Proceeding of Earth and Environmental Science, Vol. 347, No. 1, p. 012130, 2019.
- [23] BRD. M. Hamdi, T. Dewi, and Rusdianasari, "Performance Comparison of 3 Kwp Solar Panels Between Fixed and Sun Tracking in Palembang-Indonesia," In Proceeding of IOP Conference Series: Earth and Environmental Science, Vol. 347, No. 1, p. 012131, 2019.

#### BIOGRAPHIES OF AUTHORS

	<p><b>Muhammad Zulfahmi,</b> Date of Birth : 29<sup>th</sup> of June 1968 Place of Birth : Lahat, South of Sumatera, Indonesia Mining Engineering Department, Sriwijaya University, Palembang, Indonesia Currently serving in the Internal Control Unit (SPI) at PT Bukit Asam, Tbk as an intermediate examiner</p>
	<p><b>RD. Kusumanto, S.T., M.M.</b> Date of Birth : 11<sup>th</sup> of March 1966 Place Of Birth : Air Dingin, Bengkulu, Indonesia Electrical Engineering Department, Politeknik Negeri Sriwijaya, Palembang, Indonesia</p>
	<p><b>Dr. Yohandri Bow, M.S.,</b> was born in Curup on 23rd October 1971. He earned a bachelor's degree in Chemical Engineering from Universitas Sriwijaya in 1995. He continued pursuing postgraduate in 2000 and graduated in 2003 with a Master Degree in Chemistry from Universitas Padjadjaran. He graduated with Doctoral Degree in Environmental Science 2017 from Universitas Sriwijaya, Palembang, Indonesia. The study programs taught include D3 Chemical Engineering since 1994, D4 Energy Engineering since 2014, and Renewable Energy Masters since 2019.</p>

# Automatic Cleaning System Design to Increase PV Panel Output Power

---

## ORIGINALITY REPORT

---

19%

SIMILARITY INDEX

19%

INTERNET SOURCES

3%

PUBLICATIONS

0%

STUDENT PAPERS

---

## PRIMARY SOURCES

---

1

journal.gpp.or.id

Internet Source

19%

---

Exclude quotes On

Exclude matches < 3%

Exclude bibliography On