

LAMPIRAN

CPM (CRITICAL PATH METHOD)

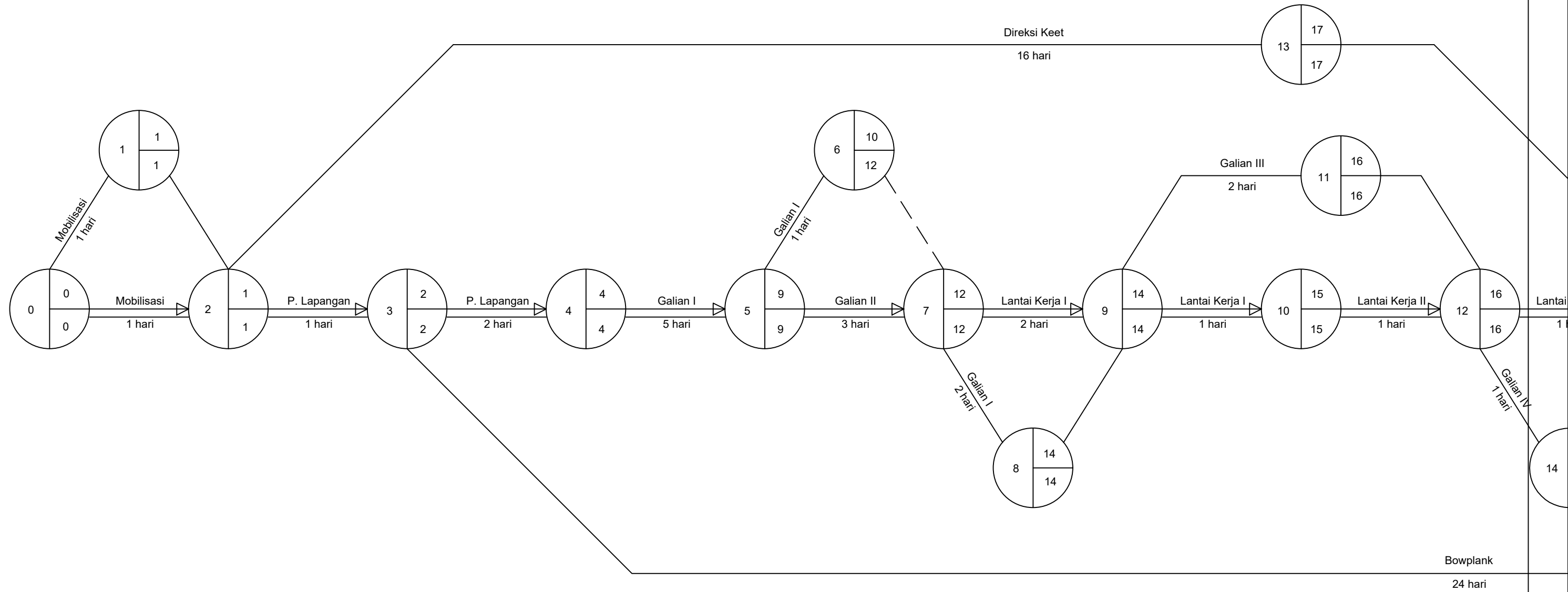

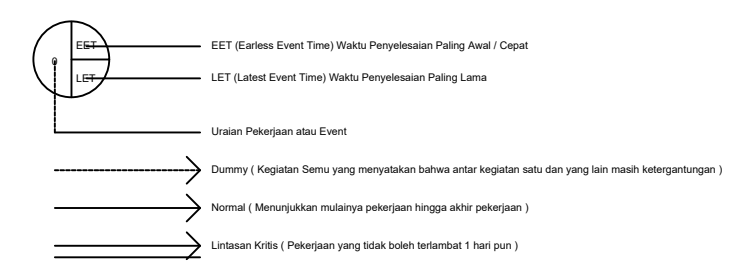

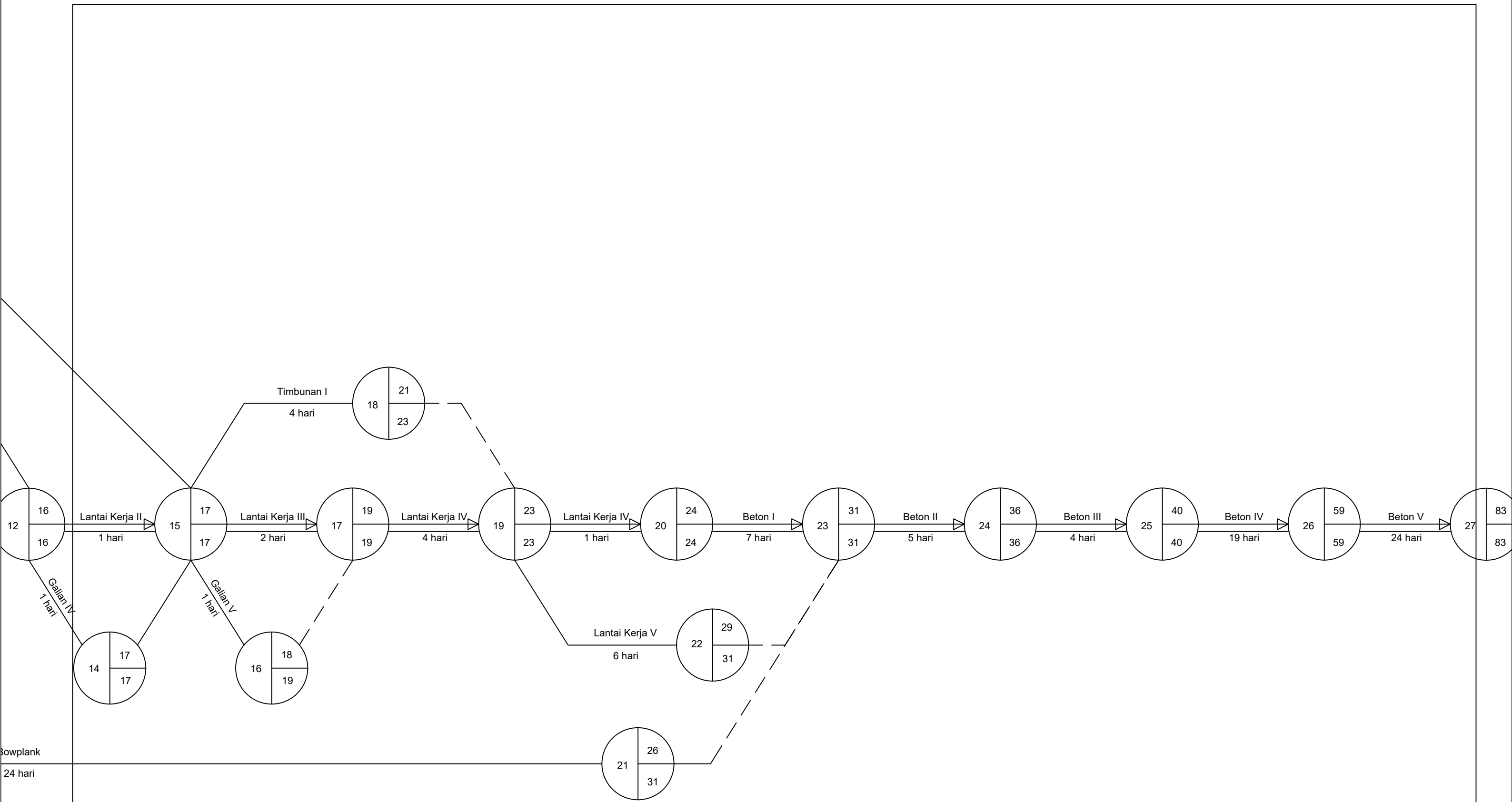
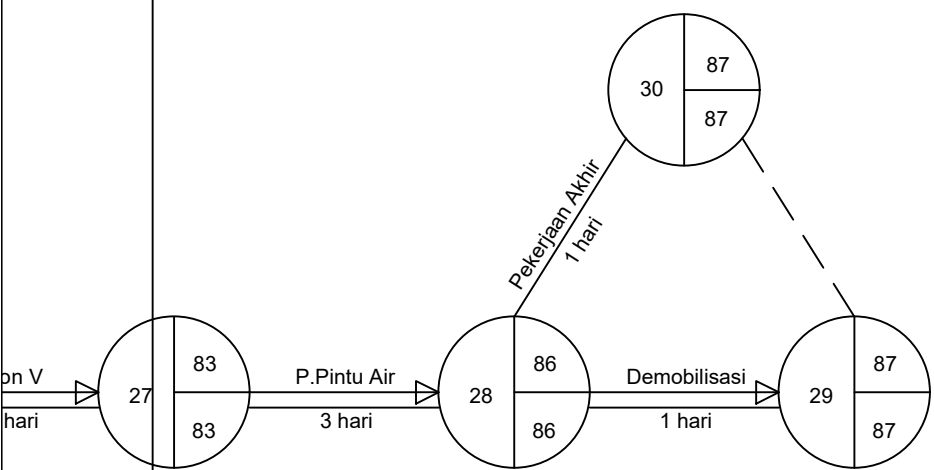

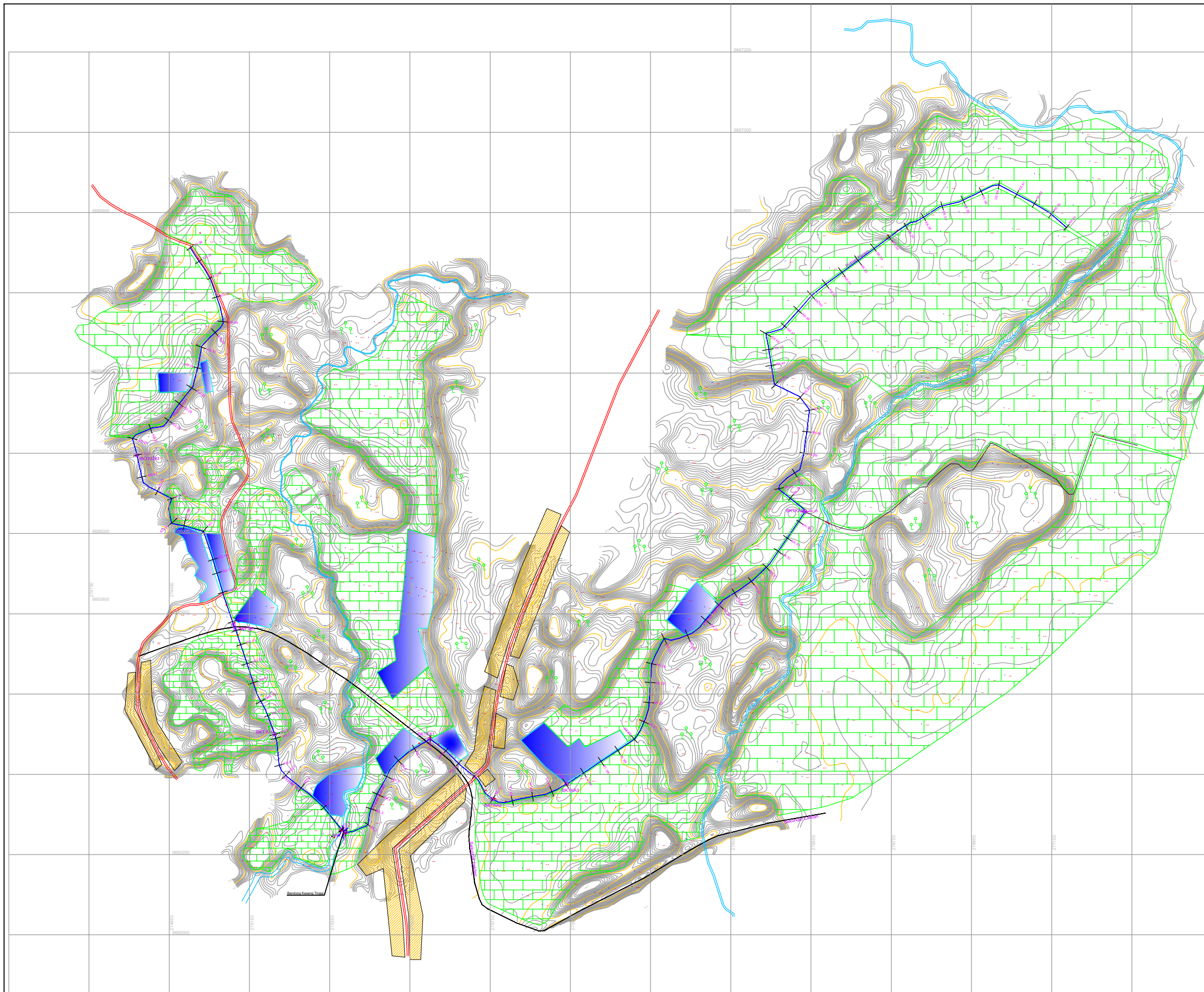

LEGENDA

TITIK TETAP	TRANSPORTASI	PERAIRAN
Bench Mark	Jalan Kolektor / Propinsi	Sungai dan Kali
Control Point	Jalan Lokal	Saluran Irigasi :
	Jalan Lain	a. Induk
	Jalan Setapak	b. Sekunder
	Jalan K.A	c. Sadap Bagi
UNSUR KETINGGIAN	Pemukiman	Tambak
58.3 Titik Tinggi (M)	Kebun Campuran (Jagung, Tebu, tembakau, buah-buahan, dll)	Rawa
Kontur Indeks & Interval		Garis Pantai
PERTANIAN	BATAS ADMINISTRASI	
Ladang	Batas Kelurahan/Desa	
Pohon	Batas Kecamatan	
Sawah	Batas Kabupaten	
Semak Belukar	Batas Area Pemetaan	
BAGUNAN UTAMA	BANGUNAN PELENGKAP	
Bendung	Drain Masuk	
Bangunan Bagi	Gorong - gorong Silang	
Bangunan Sadap	Arah Aliran	
Bangunan Bagi Sadap	Corongan	
Box Tersier	Gorong - gorong	
Box Kwarter	Jembatan	
SALURAN PEMBAWA	SALURAN PEMBUANG	
Saluran Induk (Eksisting)	Saluran Pembuang Induk (Eksisting)	
Saluran Sekunder (Eksisting)	Saluran Pembuang Sekunder (Eksisting)	
Saluran Tersier (Eksisting)	Saluran Pembuang Tersier (Eksisting)	
Saluran Kwarter (Eksisting)	Saluran Pembuang Kwarter (Rencana)	
Saluran Tersier (Rencana)	Drainase Tersier (dt)	
Saluran Kwarter (Rencana)	Drainase Kwarter (dk)	

KELAS :	JUDUL :	DISETUJUI :	PARAF :	DIGAMBAR :	PARAF :	KONSENTRASI :	
6 SB	PERENCANAAN PENINGKATAN JARINGAN IRIGASI D.I KASANG TINGGI KABUPATEN MUSI RAWAS PROVINSI SUMATERA SELATAN	JURUSAN TEKNIK SIPIL POLITEKNIK NEGERI SRIWIJAYA PALEMBANG	Zainuddin Muchtar, S.T., M.T. NIP : 196501251989031002	Riken Biloner Angga Reksa NPM : 062030100600		BANGUNAN AIR	
						SKALA	NO.GAMBAR
						1:200000	31
		Ir. Herlinawati, M.Eng NIP : 196210201988032001		Reynaldy Prayoga Syaputra NPM : 062030100578			

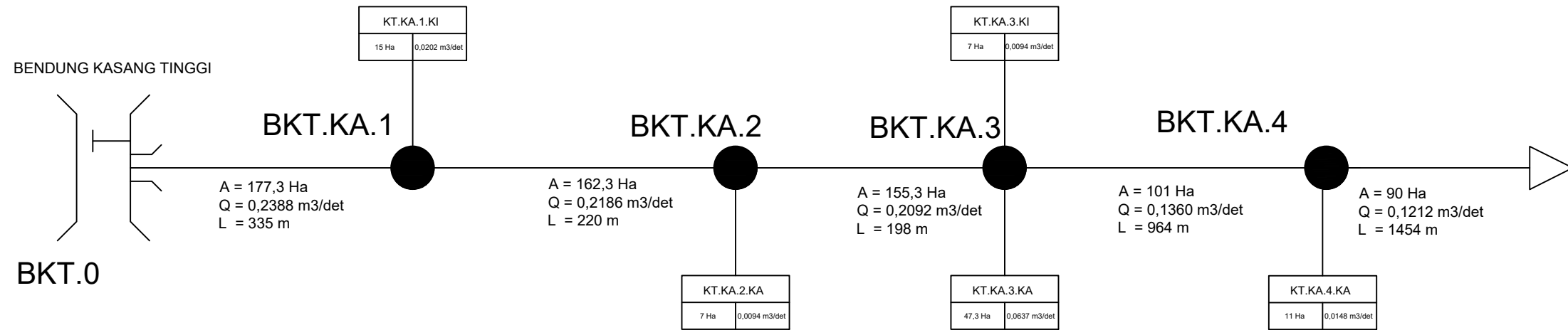

SKEMA JARINGAN D.I KASANG TINGGI
SKALA : -

KELAS :	JUDUL :	JURUSAN TEKNIK SIPIL POLITEKNIK NEGERI SRIWIJAYA PALEMBANG	DISETUJUI :	PARAF	DIGAMBAR :	PARAF	KONSENTRASI :	
6 SB	PERENCANAAN PENINGKATAN JARINGAN IRIGASI D.I KASANG TINGGI KABUPATEN MUSI RAWAS PROVINSI SUMATERA SELATAN		Zainuddin Muchtar, S.T., M.T. NIP : 196501251989031002		Riken Billioner Angga Rekso NPM : 062030100600		BANGUNAN AIR	
		Ir. Herlinawati, M.Eng NIP : 196210201988032001		Reynaldy Prayoga Syaputra NPM : 062030100578		SKALA	NO.GAMBAR	
							1	

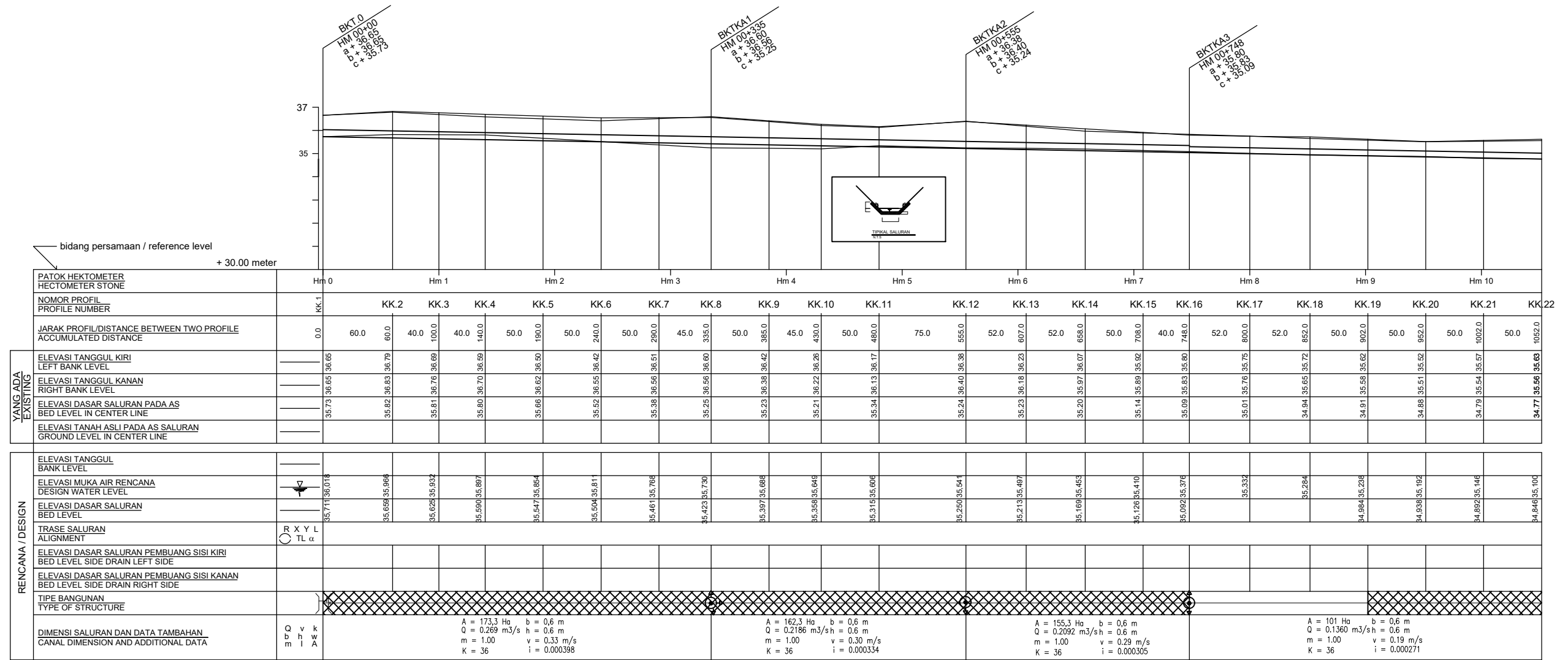

POTONGAN MEMANJANG
SKALA : 1 : 4000

KELAS :	JUDUL :	DISETUJUI :	PARAF :	DIGAMBAR :	PARAF :	KONSENTRASI :		
6 SB	PERENCANAAN PENINGKATAN JARINGAN IRRIGASI D.I KASANG TINGGI KABUPATEN MUSI RAWAS PROVINSI SUMATERA SELATAN	JURUSAN TEKNIK SIPIL POLITEKNIK NEGERI SRIWIJAYA PALEMBANG	Zainuddin Muchtar, S.T., M.T. NIP : 196510251989031002	Riken Biloner Angga Rekso NPM : 062030100600	PARAF	BANGUNAN AIR		
			Ir. Herlinawati, M.Eng NIP : 196210201988032001				Reynaldy Prayoga Syaputra NPM : 062030100578	SKALA
							1 : 4000	4

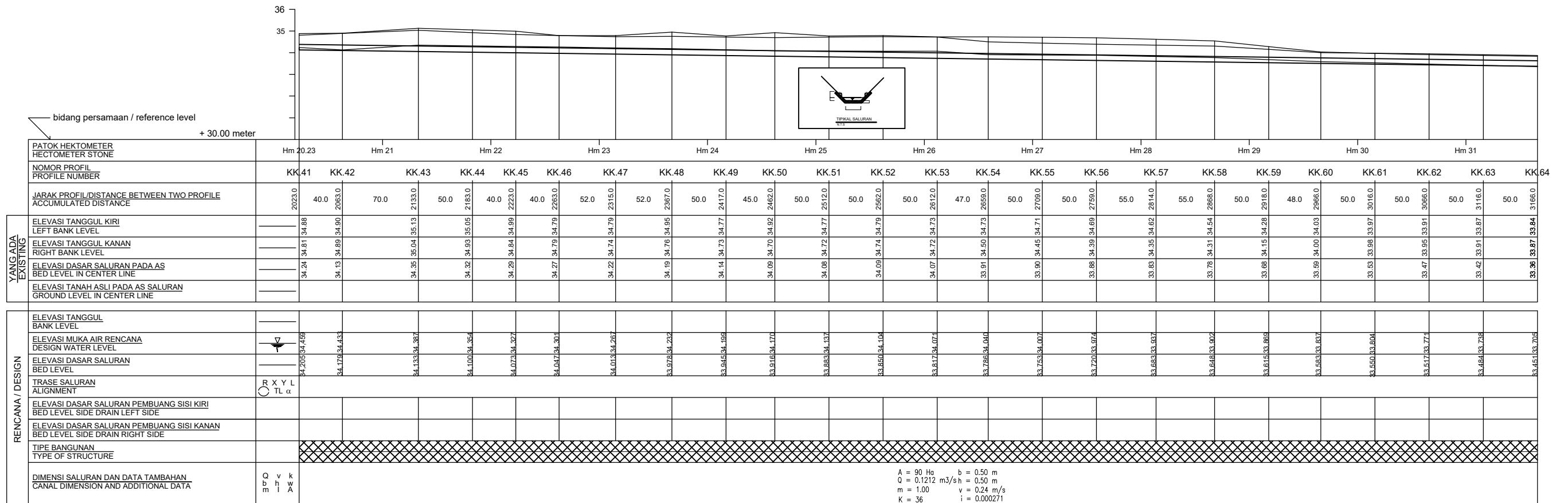

POTONGAN MEMANJANG
SKALA : 1 : 4000

KELAS :	JUDUL :	JURUSAN TEKNIK SIPIL POLITEKNIK NEGERI SRIWIJAYA PALEMBANG	DISETUJUI :	PARAF	DIGAMBAR :	PARAF	KONSENTRASI :	
6 SB	PERENCANAAN PENINGKATAN JARINGAN IRIGASI D.I KASANG TINGGI KABUPATEN MUSI RAWAS PROVINSI SUMATERA SELATAN		Zainuddin Muchtar, S.T., M.T. NIP : 196501251989031002	Riken Billioner Angga Reksa NPM : 062030100600	Reynaldy Prayoga Syaputra NPM : 062030100578	BANGUNAN AIR		
			Ir. Herlinawati, M.Eng NIP : 196210201988032001			SKALA	NO.GAMBAR	
					1 : 4000	6		

KK.1

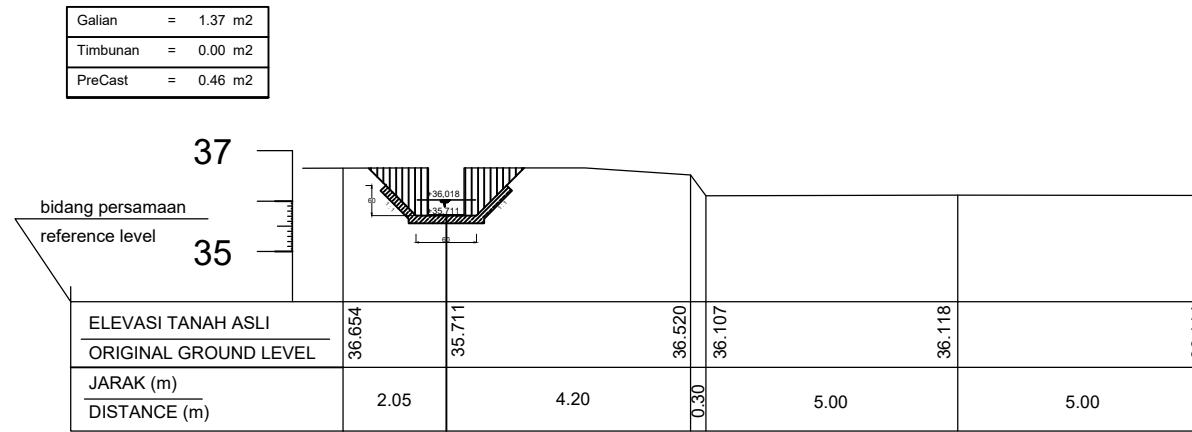

KK.2

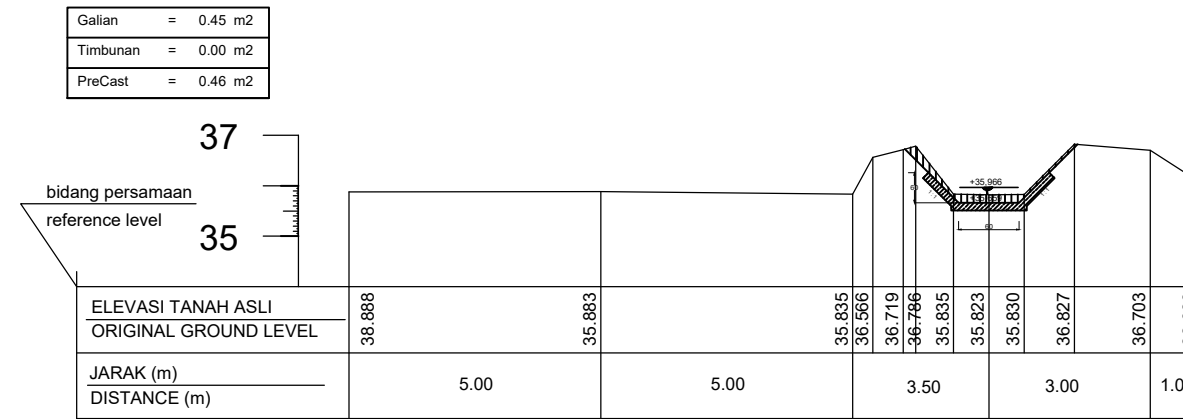

KK.3

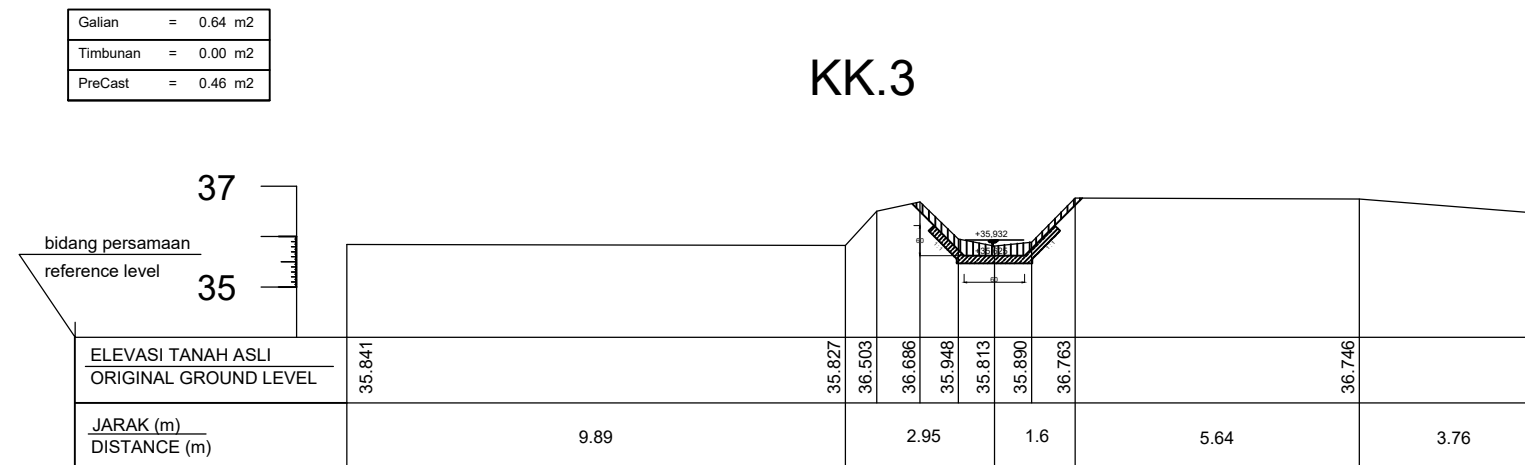

POTONGAN MELINTANG
SKALA : 1:150

KELAS :	JUDUL :		DISETUJUI :	PARAF	DIGAMBAR :	PARAF	KONSENTRASI :
6 SB	PERENCANAAN PENINGKATAN JARINGAN IRIGASI D.I KASANG TINGGI KABUPATEN MUSI RAWAS PROVINSI SUMATERA SELATAN	JURUSAN TEKNIK SIPIL POLITEKNIK NEGERI SRIWIJAYA PALEMBANG	Zainuddin Muchtar, S.T., M.T. NIP : 196501251989031002		Riken Biloner Angga Rekza NPM : 062030100600		BANGUNAN AIR
			Ir. Herlinawati, M.Eng NIP : 196210201988032001		Reynaldy Prayoga Syaputra NPM : 062030100578	SKALA	NO.GAMBAR
						1 : 150	7

KK.10

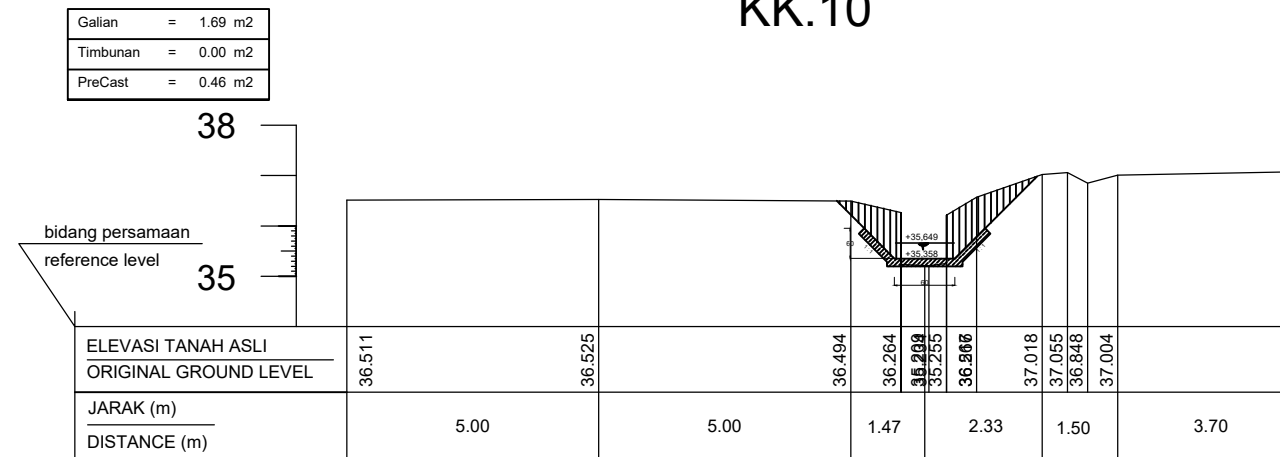

KK.11

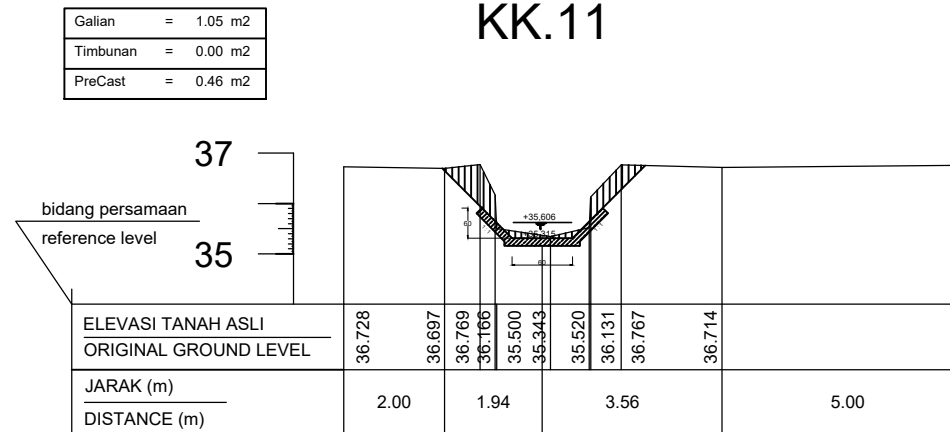

KK.12

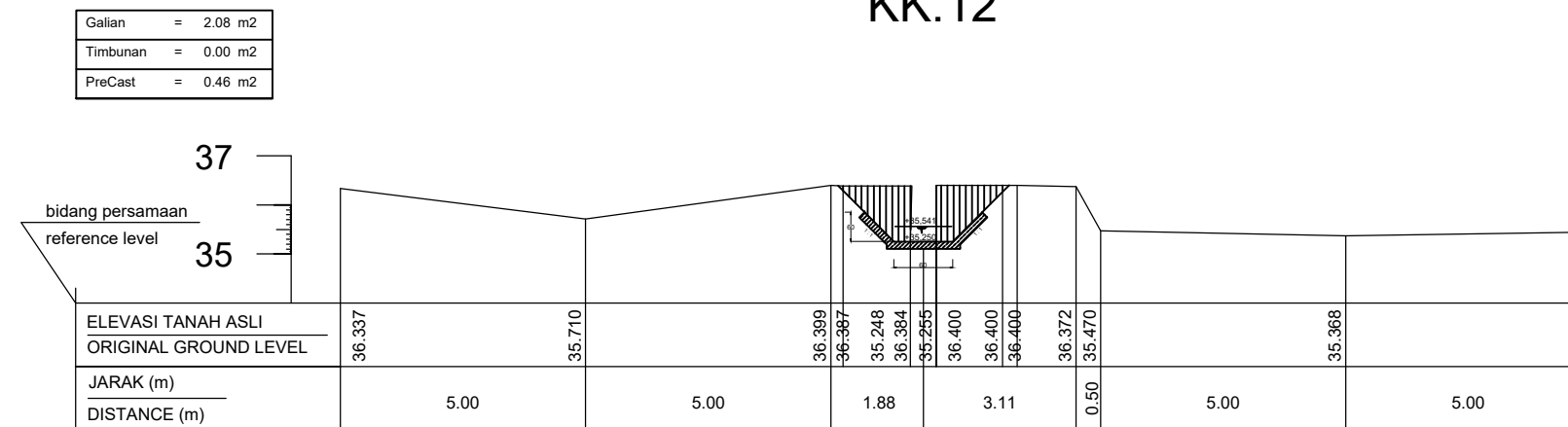

POTONGAN MELINTANG
SKALA : 1:150

KELAS :	JUDUL :		DISETUJUI :	PARAF	DIGAMBAR :	PARAF	KONSENTRASI :
6 SB	PERENCANAAN PENINGKATAN JARINGAN IRIGASI D.I KASANG TINGGI KABUPATEN MUSI RAWAS PROVINSI SUMATERA SELATAN	JURUSAN TEKNIK SIPIL POLITEKNIK NEGERI SRIWIJAYA PALEMBANG	Zainuddin Muchtar, S.T., M.T. NIP : 196501251989031002		Riken Biloner Angga Reksa NPM : 062030100600		BANGUNAN AIR
			Ir. Herlinawati, M.Eng NIP : 196210201988032001		Reynaldy Prayoga Syaputra NPM : 062030100578	SKALA	NO.GAMBAR
						1 : 150	10

Galian	= 0.72 m2
Timbunan	= 0.00 m2
PreCast	= 0.46 m2

KK.16

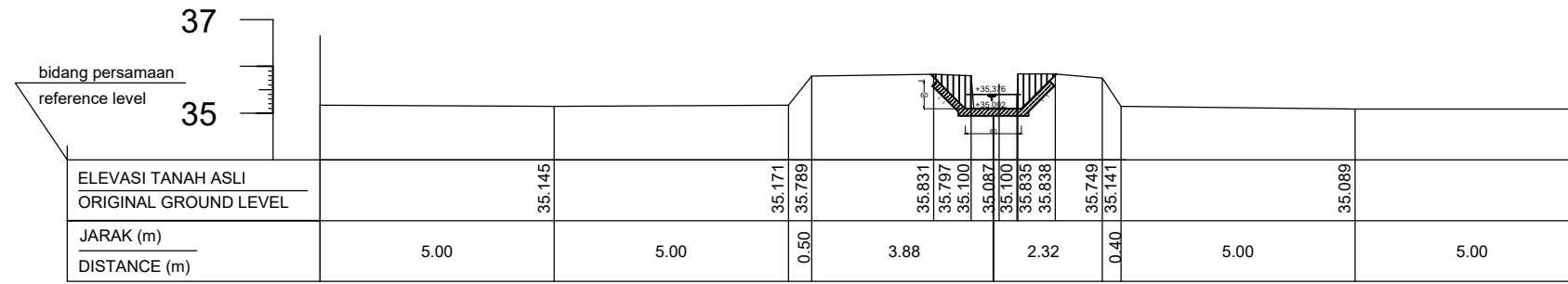

Galian	= 0.00 m2
Timbunan	= 0.00 m2
PreCast	= 0.00 m2

KK.17

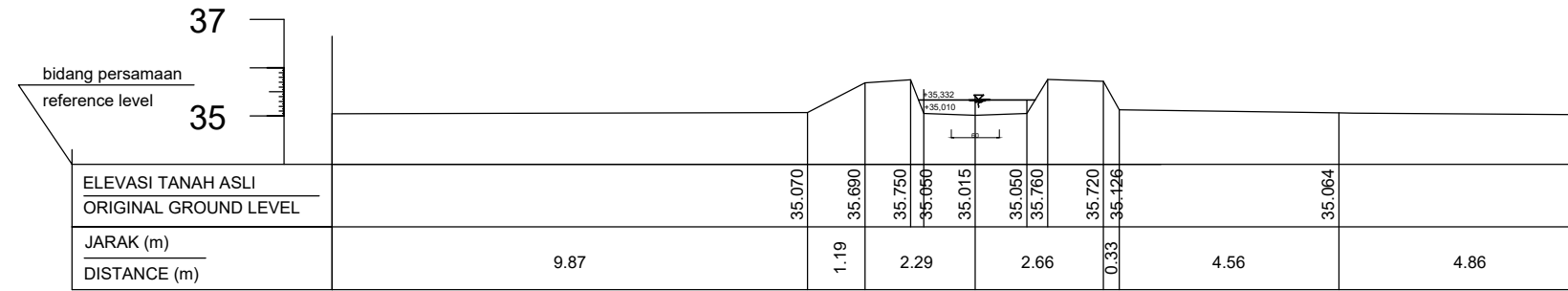

Galian	= 0.00 m2
Timbunan	= 0.00 m2
PreCast	= 0.00 m2

KK.18

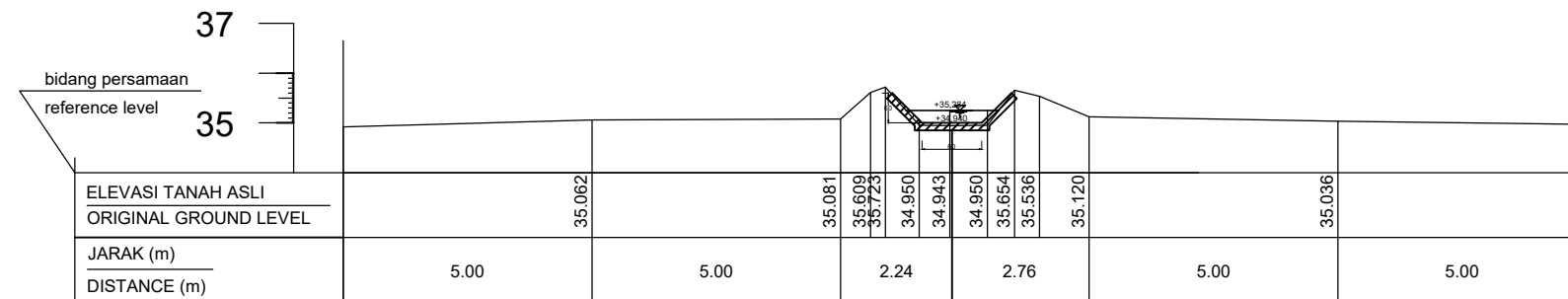

POTONGAN MELINTANG
SKALA : 1:150

KELAS :	JUDUL :		DISETUJUI :	PARAF	DIGAMBAR :	PARAF	KONSENTRASI :	
6 SB	PERENCANAAN PENINGKATAN JARINGAN IRIGASI D.I KASANG TINGGI KABUPATEN MUSI RAWAS PROVINSI SUMATERA SELATAN	JURUSAN TEKNIK SIPIL POLITEKNIK NEGERI SRIWIJAYA PALEMBANG	Zainuddin Muchtar, S.T., M.T. NIP : 196501251989031002		Riken Biloner Angga Reksa NPM : 062030100600		BANGUNAN AIR	
			Ir. Herlinawati, M.Eng NIP : 196210201988032001		Reynaldy Prayoga Syaputra NPM : 062030100578		SKALA	NO.GAMBAR
							1 : 150	12

Galian	= 0.00 m ²
Timbunan	= 0.58 m ²
PreCast	= 0.43 m ²

KK.25

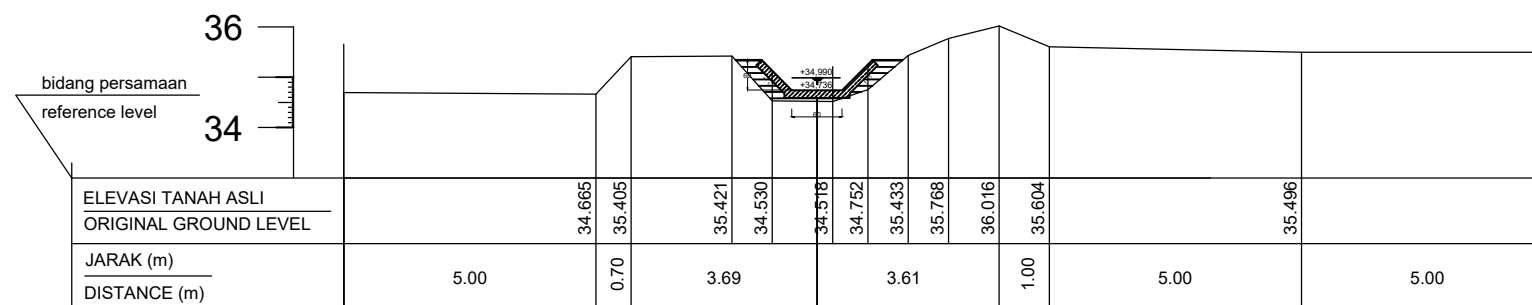

KK.26

Galian	= 0.00 m ²
Timbunan	= 0.20 m ²
PreCast	= 0.43 m ²

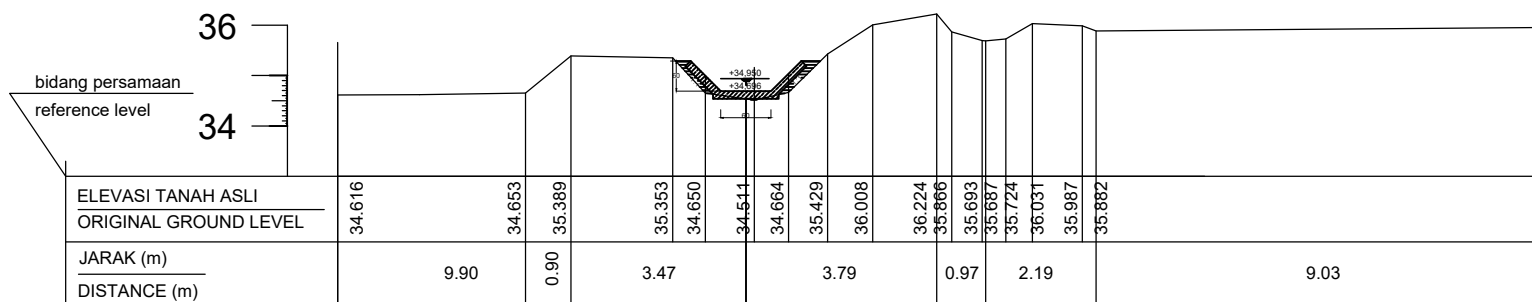

Galian	= 0.00 m ²
Timbunan	= 0.009 m ²
PreCast	= 0.43 m ²

KK.27

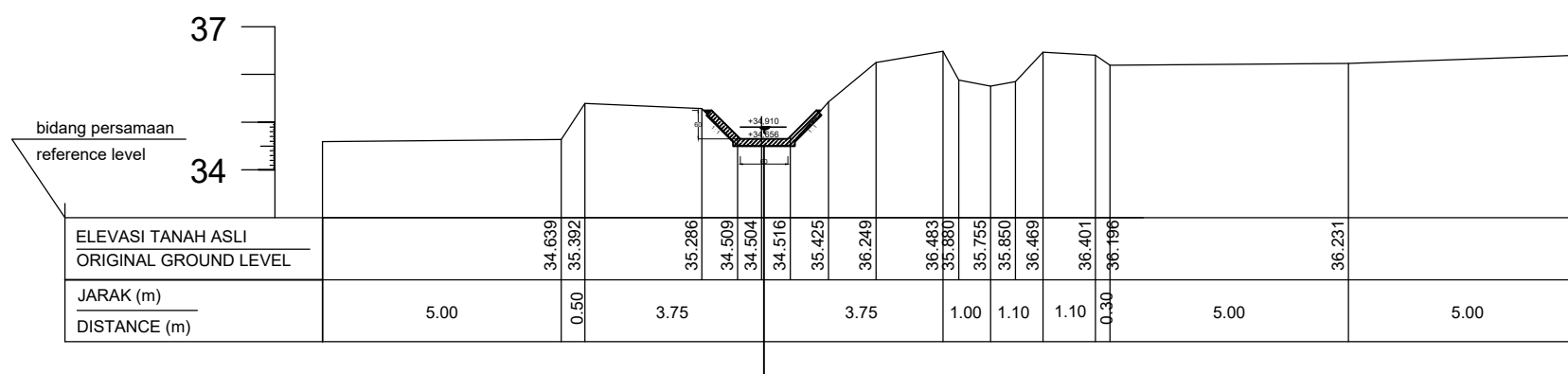

POTONGAN MELINTANG
SKALA : 1:150

KELAS :	JUDUL :		DISETUJUI :	PARAF	DIGAMBAR :	PARAF	KONSENTRASI :	
6 SB	PERENCANAAN PENINGKATAN JARINGAN IRIGASI D.I KASANG TINGGI KABUPATEN MUSI RAWAS PROVINSI SUMATERA SELATAN	JURUSAN TEKNIK SIPIL POLITEKNIK NEGERI SRIWIJAYA PALEMBANG	Zainuddin Muchtar, S.T., M.T. NIP : 196501251989031002		Riken Biloner Angga Reksa NPM : 062030100600		BANGUNAN AIR	
			Ir. Herlinawati, M.Eng NIP : 196210201988032001		Reynaldy Prayoga Syaputra NPM : 062030100578		SKALA	NO.GAMBAR
							1 : 150	15

KK.31

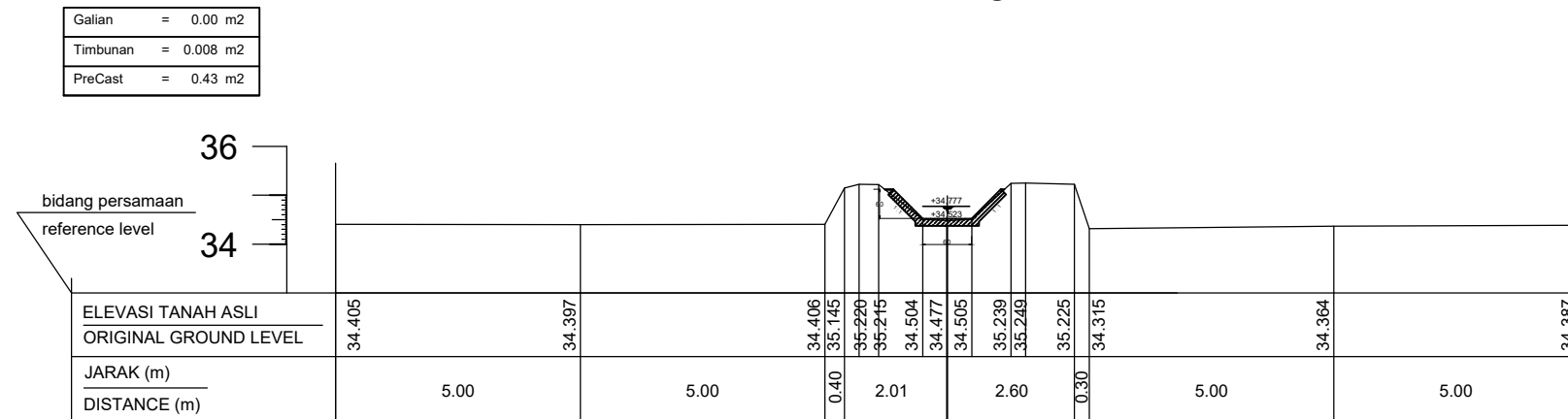

KK.32

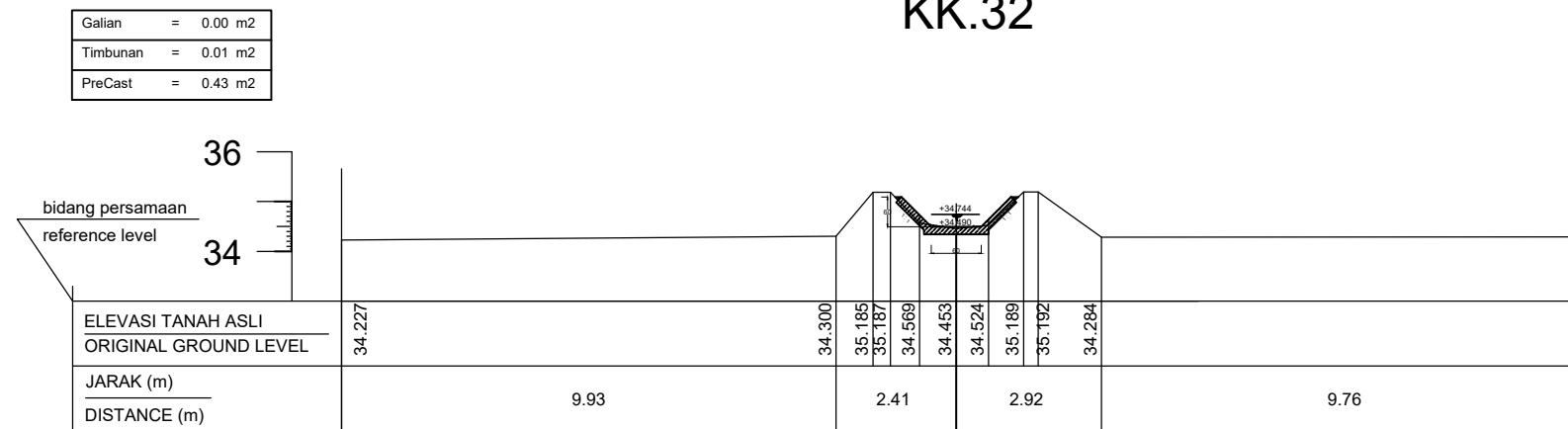

KK.33

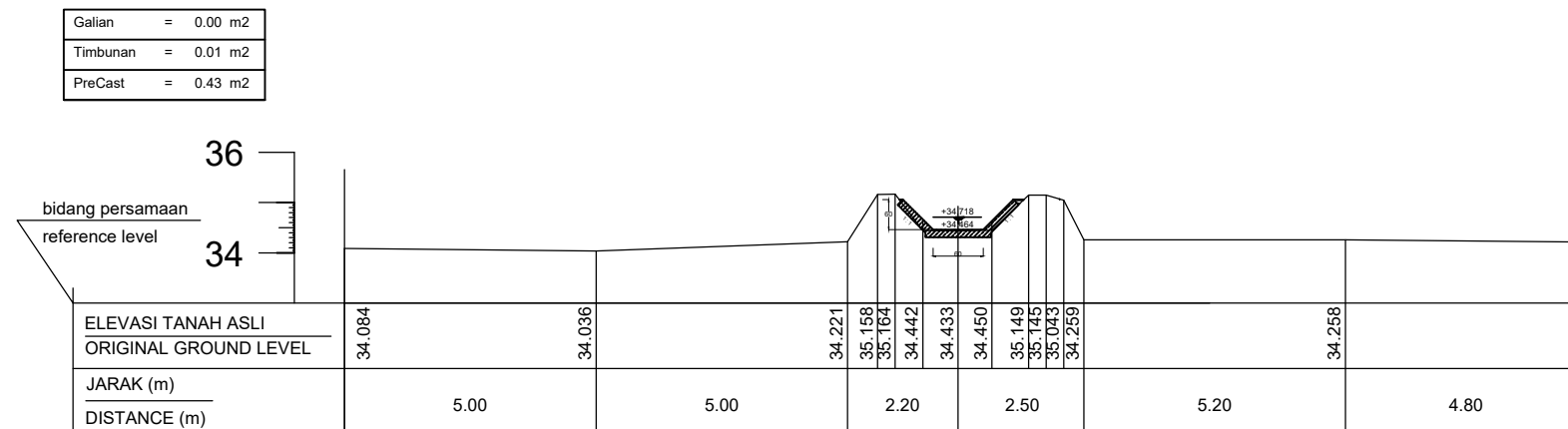

POTONGAN MELINTANG
SKALA : 1:150

KELAS :	JUDUL :		DISETUJUI :	PARAF	DIGAMBAR :	PARAF	KONSENTRASI :
6 SB	PERENCANAAN PENINGKATAN JARINGAN IRIGASI D.I KASANG TINGGI KABUPATEN MUSI RAWAS PROVINSI SUMATERA SELATAN	JURUSAN TEKNIK SIPIL POLITEKNIK NEGERI SRIWIJAYA PALEMBANG	Zainuddin Muchtar, S.T., M.T. NIP : 196501251989031002		Riken Biloner Angga Rekso NPM : 062030100600		BANGUNAN AIR
			Ir. Herlinawati, M.Eng NIP : 196210201988032001		Reynaldy Prayoga Syaputra NPM : 062030100578	SKALA	NO.GAMBAR
						1 : 150	17

KK.46

Galian	= 2.49 m ²
Timbunan	= 0.00 m ²
PreCast	= 0.40 m ²



KK.47

Galian	= 0.72 m ²
Timbunan	= 0.00 m ²
PreCast	= 0.40 m ²

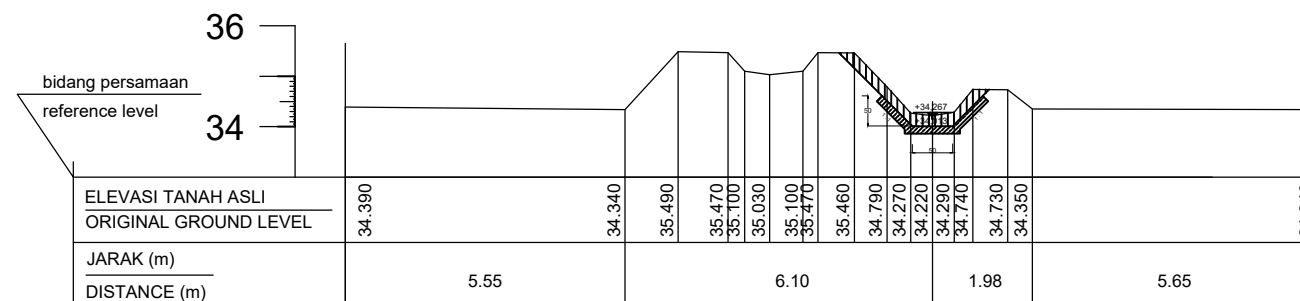

KK.48

Galian	= 0.95 m ²
Timbunan	= 0.00 m ²
PreCast	= 0.40 m ²



POTONGAN MELINTANG
SKALA : 1:150

KELAS :	JUDUL :		DISETUJUI :	PARAF	DIGAMBAR :	PARAF	KONSENTRASI :
6 SB	PERENCANAAN PENINGKATAN JARINGAN IRIGASI D.I KASANG TINGGI KABUPATEN MUSI RAWAS PROVINSI SUMATERA SELATAN	JURUSAN TEKNIK SIPIL POLITEKNIK NEGERI SRIWIJAYA PALEMBANG	Zainuddin Muchtar, S.T., M.T. NIP : 196501251989031002		Riken Biloner Angga Rekso NPM : 062030100600		BANGUNAN AIR
			Ir. Herlinawati, M.Eng NIP : 196210201988032001		Reynaldy Prayoga Syaputra NPM : 062030100578	SKALA	NO.GAMBAR
						1 : 150	22

KK.52

Galian	= 0.96 m ²
Timbunan	= 0.00 m ²
PreCast	= 0.40 m ²

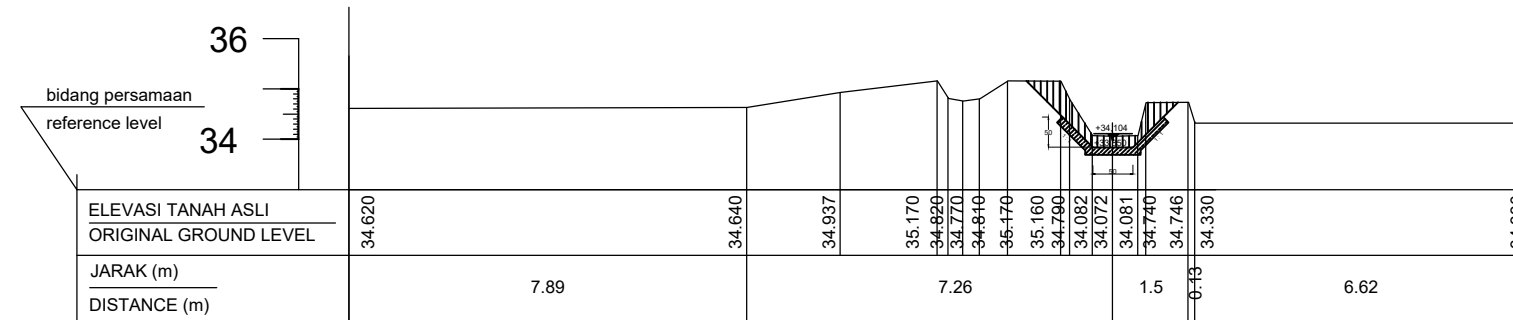

KK.53

Galian	= 1.01 m ²
Timbunan	= 0.00 m ²
PreCast	= 0.40 m ²

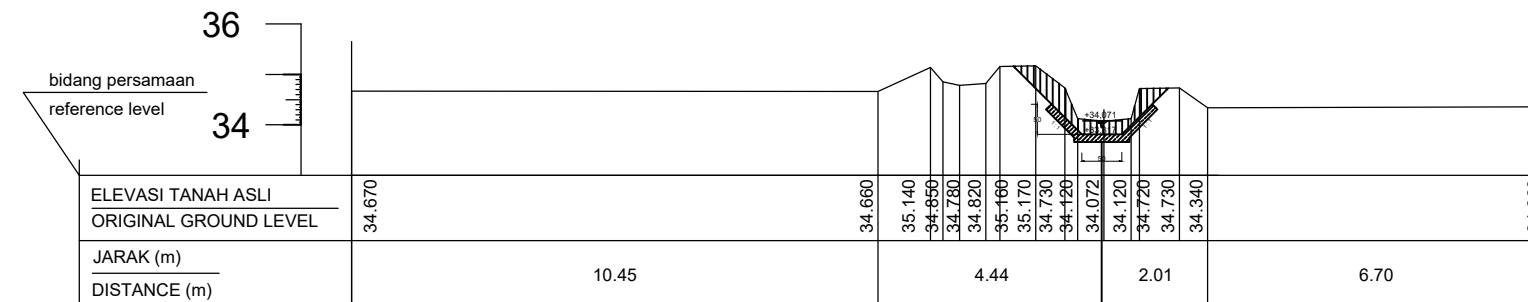

KK.54

Galian	= 0.67 m ²
Timbunan	= 0.00 m ²
PreCast	= 0.40 m ²

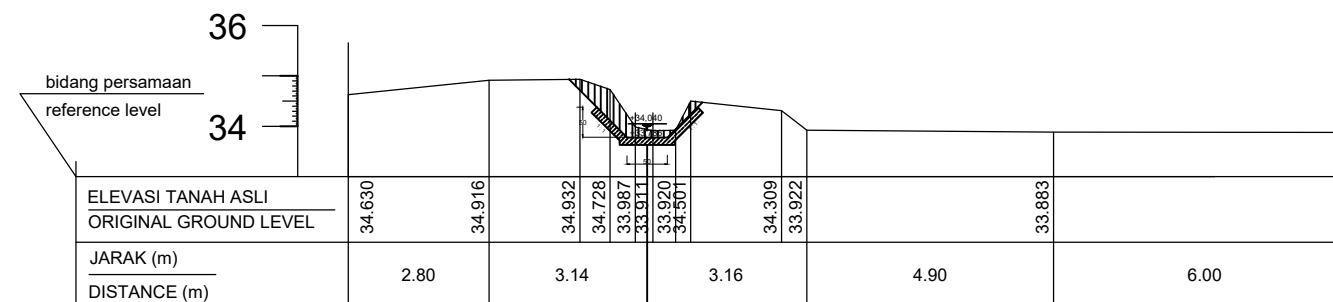

POTONGAN MELINTANG
SKALA : 1:150

KELAS :	JUDUL :		DISETUJUI :	PARAF	DIGAMBAR :	PARAF	KONSENTRASI :	
6 SB	PERENCANAAN PENINGKATAN JARINGAN IRIGASI D.I KASANG TINGGI KABUPATEN MUSI RAWAS PROVINSI SUMATERA SELATAN	JURUSAN TEKNIK SIPIL POLITEKNIK NEGERI SRIWIJAYA PALEMBANG	Zainuddin Muchtar, S.T., M.T. NIP : 196501251989031002		Riken Biloner Angga Reksa NPM : 062030100600		BANGUNAN AIR	
			Ir. Herlinawati, M.Eng NIP : 196210201988032001		Reynaldy Prayoga Syaputra NPM : 062030100578		SKALA	NO.GAMBAR
						1 : 150	24	

KK.58

Galian	= 0.23 m ²
Timbunan	= 0.00 m ²
PreCast	= 0.40 m ²

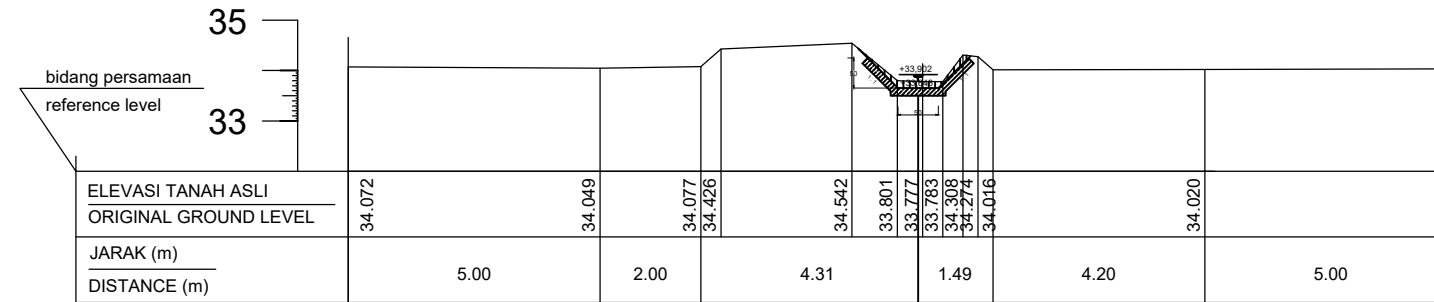

KK.59

Galian	= 0.09 m ²
Timbunan	= 0.16 m ²
PreCast	= 0.40 m ²

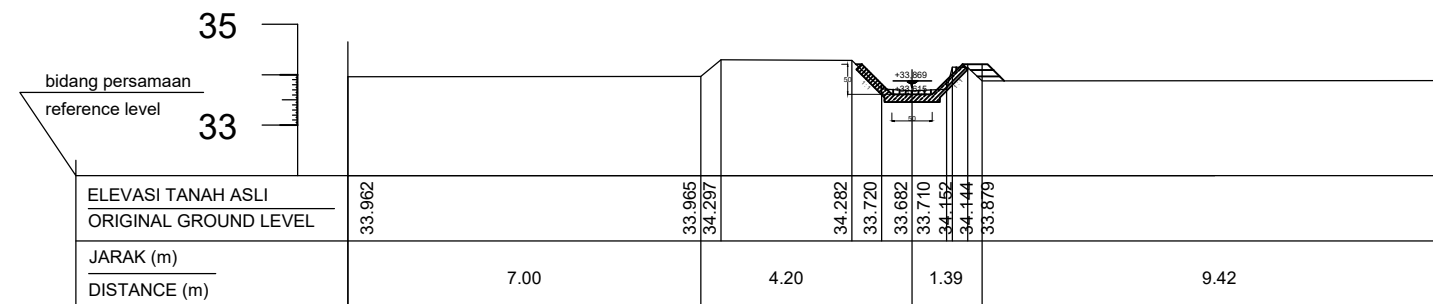

KK.60

Galian	= 0.03 m ²
Timbunan	= 0.29 m ²
PreCast	= 0.40 m ²

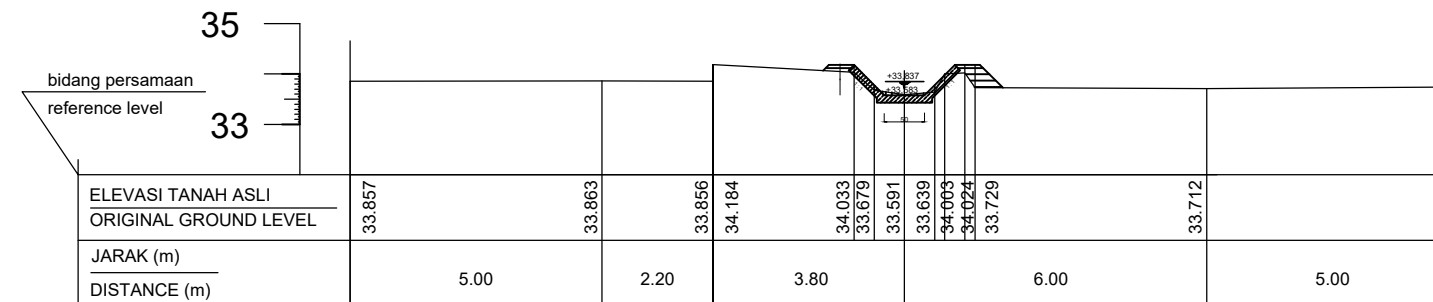

POTONGAN MELINTANG
SKALA : 1:150

KELAS :	JUDUL :		DISETUJUI :	PARAF	DIGAMBAR :	PARAF	KONSENTRASI :	
6 SB	PERENCANAAN PENINGKATAN JARINGAN IRIGASI D.I KASANG TINGGI KABUPATEN MUSI RAWAS PROVINSI SUMATERA SELATAN	JURUSAN TEKNIK SIPIL POLITEKNIK NEGERI SRIWIJAYA PALEMBANG	Zainuddin Muchtar, S.T., M.T. NIP : 196501251989031002		Riken Bilioner Angga Rekso NPM : 062030100600		BANGUNAN AIR	
			Ir. Herlinawati, M.Eng NIP : 196210201988032001		Reynaldy Prayoga Syaputra NPM : 062030100578		SKALA	NO.GAMBAR
							1 : 150	26

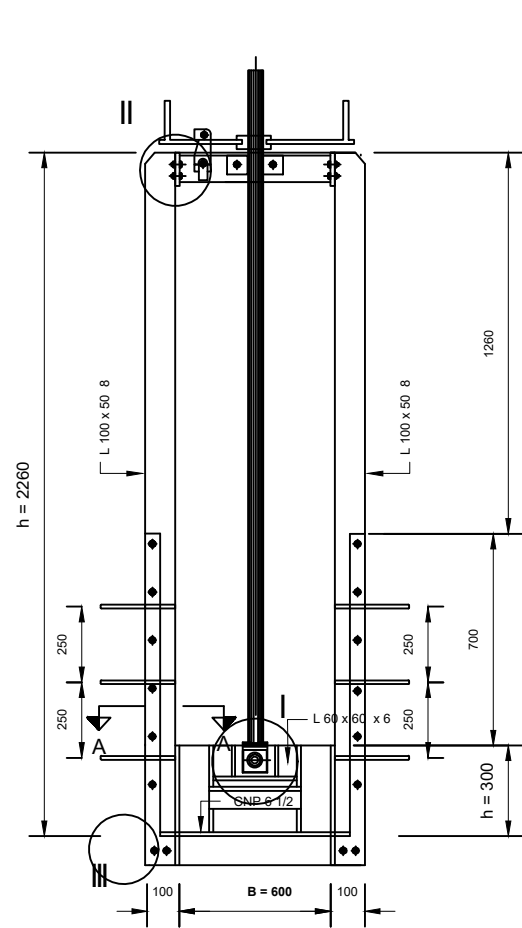

**TAMPAK DEPAN
FRONT VIEW**

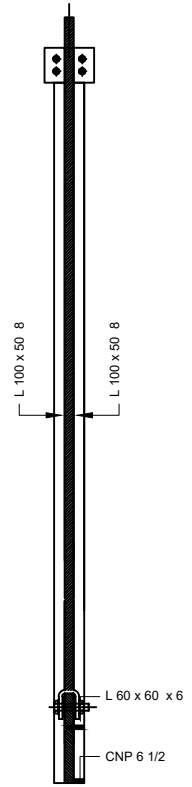

B-B

**POTONGAN
SECTION**

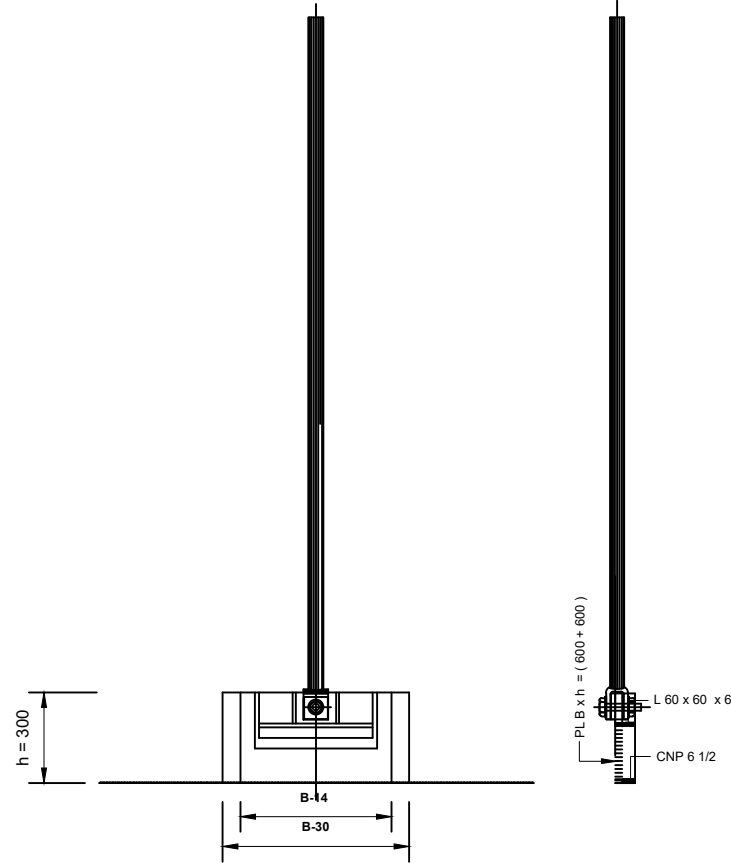

**PLAT PINTU
GATE PLATE**

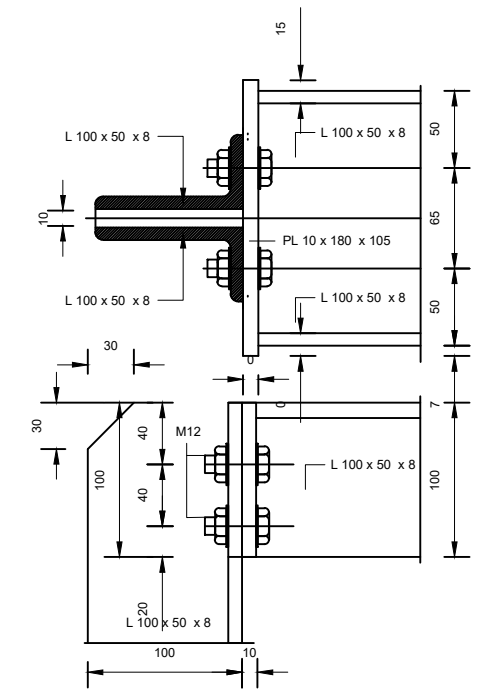
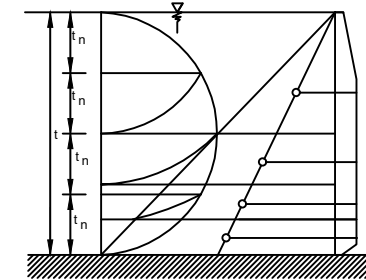

DETAIL II

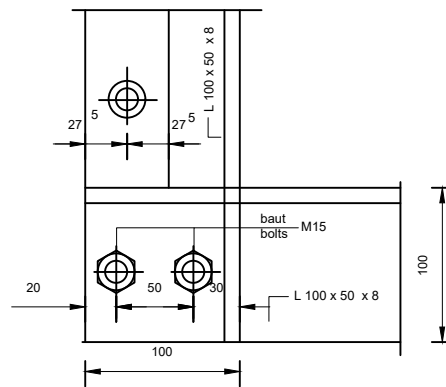
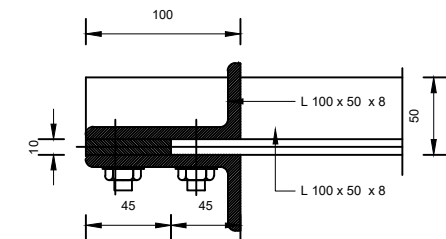

DETAIL III

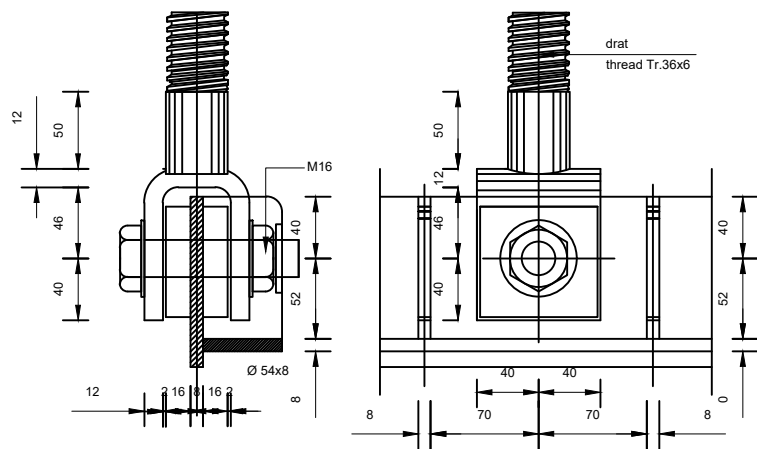

DETAIL I

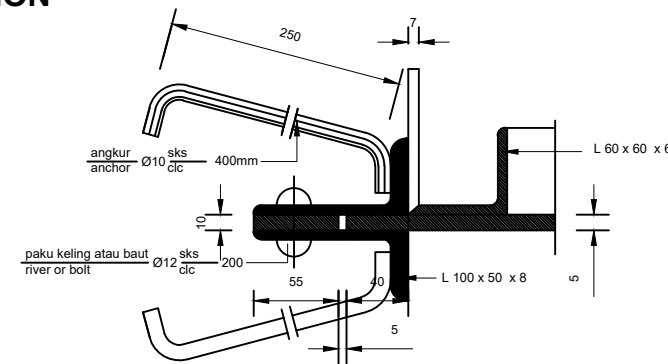

**POTONGAN
SECTION A-A**



**DETAIL PINTU AIR
SKALA : 1:250**

KELAS :	JUDUL :	JURUSAN TEKNIK SIPIL POLITEKNIK NEGERI SRIWIJAYA PALEMBANG	DISETUJUI :	PARAF	DIGAMBAR :	PARAF	KONSENTRASI :	
6 SB	PERENCANAAN PENINGKATAN JARINGAN IRIGASI D.I KASANG TINGGI KABUPATEN MUSI RAWAS PROVINSI SUMATERA SELATAN		Zainuddin Muchtar, S.T., M.T. NIP : 196501251989031002		Riken Biloner Angga Rekxa NPM : 062030100600	BANGUNAN AIR		SKALA
			Ir. Herlinawati, M.Eng NIP : 196210201988032001		Reynaldy Prayoga Syaputra NPM : 062030100578		1 : 250	29

