

	4	Baut Dudukan Motor Listrik	14	STEEL	M10 x 35	Dibeli
	1	Pipa Penghubung Toolpost	13	STEEL	Ø19 x 60 x 3	Dibuat
	1	Pulley Penggerak	12	CAST IRON	Ø72 x 40	Dibeli
	1	V-Belt	11	RUBBER	A30	Dibeli
	2	Baut Pengikat Pulley	10	STEEL	M8 x 60	Dibeli
	1	Pulley Digerakkan	9	CAST IRON	Ø76 x 40	Dibeli
	2	Bearing	8	STEEL	Ø20 x 113 x 33	Dibeli
	4	Baut Pengikat Bearing	7	STEEL	M12 x 35	Dibeli
	1	Poros Bertingkat	6	STEEL	Ø25.4 x 270	Dibuat
	2	Ring Batu Gerinda	5	STEEL	Ø75 x 7	Dibeli
	2	Mur Pengikat Poros	4	STEEL	M16 x 20	Dibeli
	1	Batu Gerinda	3	SILICON	6 Inch	Dibeli
	7	Kerangka	2	STEEL	1.500 x 1.000 x 12	Dibuat
	1	Motor Listrik	1		1720 rpm, 200 volt, 370 watt	Dibeli

Jumlah	Nama Bagian	No. Bag	Bahan	Ukuran	Keterangan
III	II	I	Perubahan :		
GERINDA SILINDRIS				Skala 1 : 2	Digambar Diperiksa Tim
Politeknik Negeri Sriwijaya Jurusan Teknik Mesin				Dra Me : AAB / 01 / 2023	

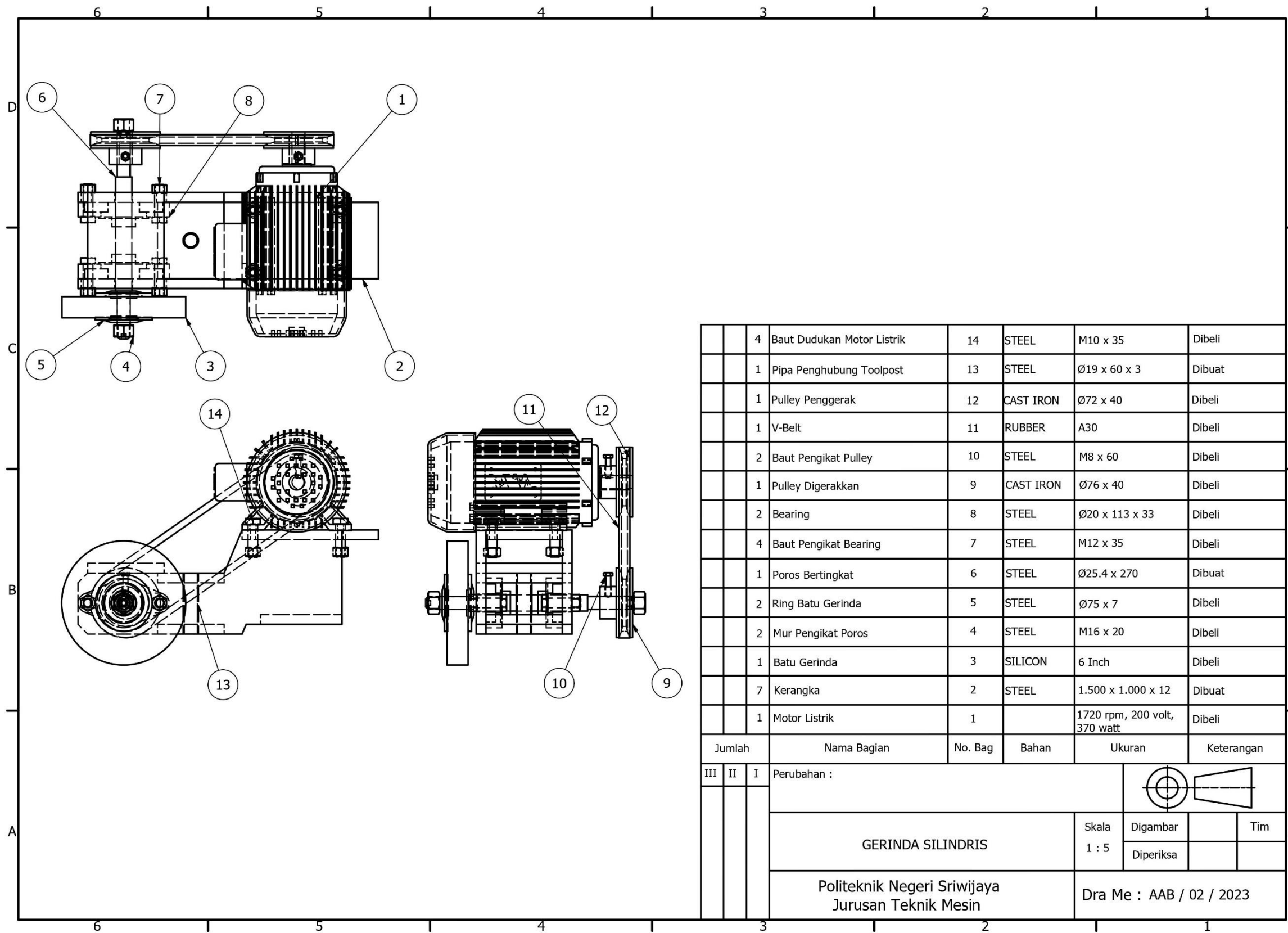

	4	Baut Dudukan Motor Listrik	14	STEEL	M10 x 35	Dibeli
	1	Pipa Penghubung Toolpost	13	STEEL	Ø19 x 60 x 3	Dibuat
	1	Pulley Penggerak	12	CAST IRON	Ø72 x 40	Dibeli
	1	V-Belt	11	RUBBER	A30	Dibeli
	2	Baut Pengikat Pulley	10	STEEL	M8 x 60	Dibeli
	1	Pulley Digerakkan	9	CAST IRON	Ø76 x 40	Dibeli
	2	Bearing	8	STEEL	Ø20 x 113 x 33	Dibeli
	4	Baut Pengikat Bearing	7	STEEL	M12 x 35	Dibeli
	1	Poros Bertingkat	6	STEEL	Ø25.4 x 270	Dibuat
	2	Ring Batu Gerinda	5	STEEL	Ø75 x 7	Dibeli
	2	Mur Pengikat Poros	4	STEEL	M16 x 20	Dibeli
	1	Batu Gerinda	3	SILICON	6 Inch	Dibeli
	7	Kerangka	2	STEEL	1.500 x 1.000 x 12	Dibuat
	1	Motor Listrik	1		1720 rpm, 200 volt, 370 watt	Dibeli
	Jumlah	Nama Bagian	No. Bag	Bahan	Ukuran	Keterangan
III	II	I	Perubahan :			
			GERINDA SILINDRIS		Skala 1 : 5	Digambar Diperiksa
			Politeknik Negeri Sriwijaya Jurusan Teknik Mesin		Dra Me : AAB / 02 / 2023	

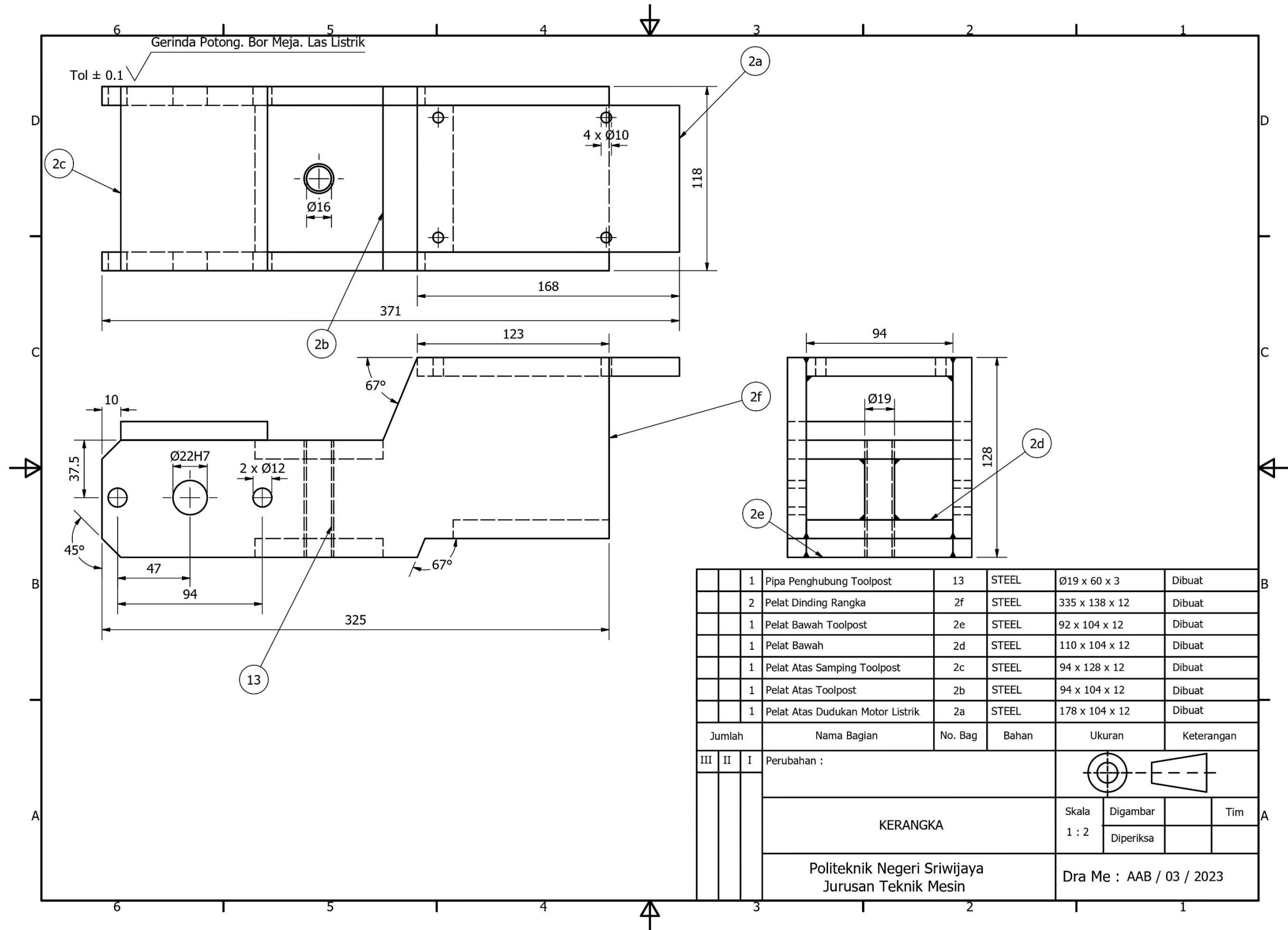

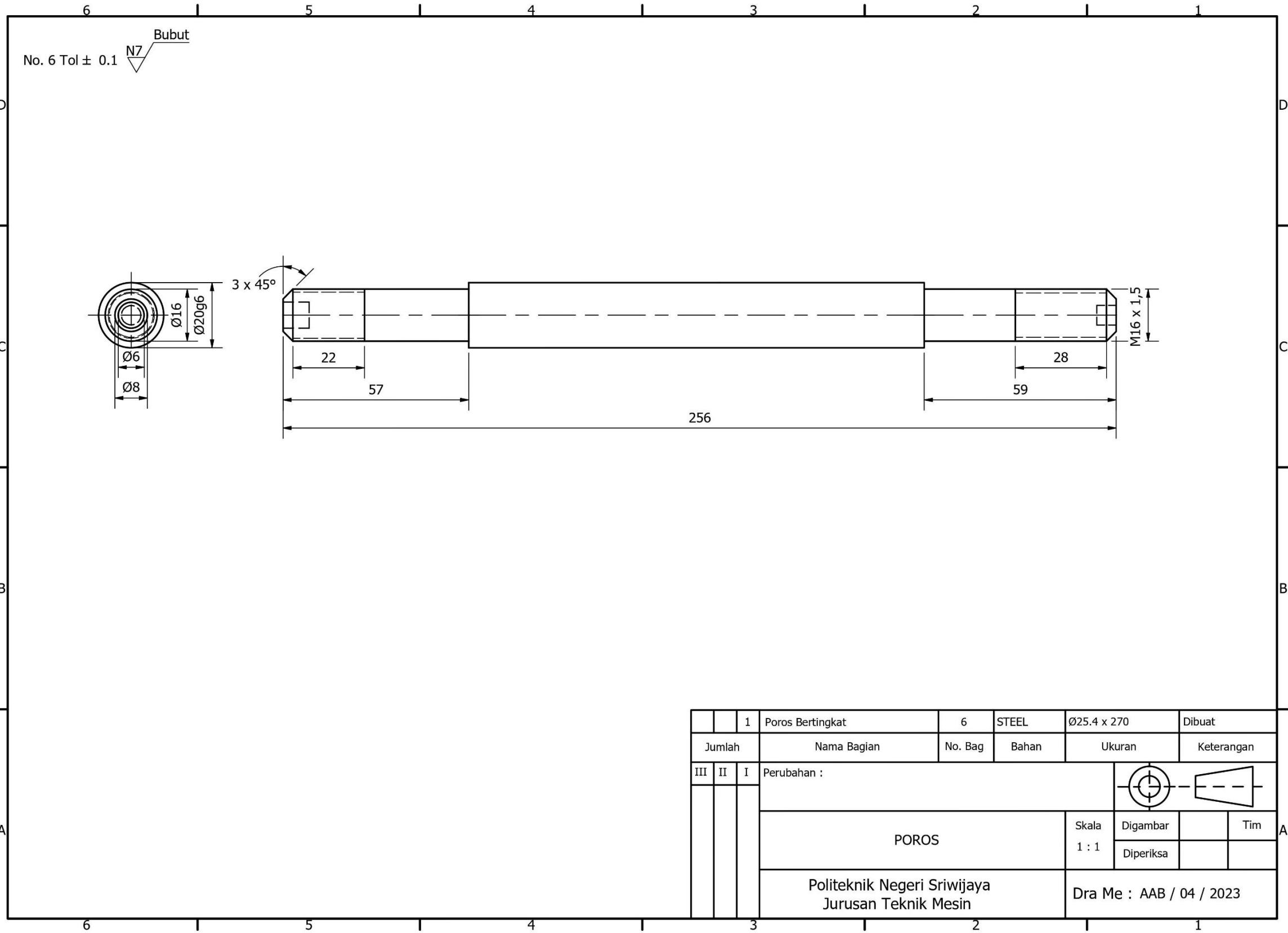

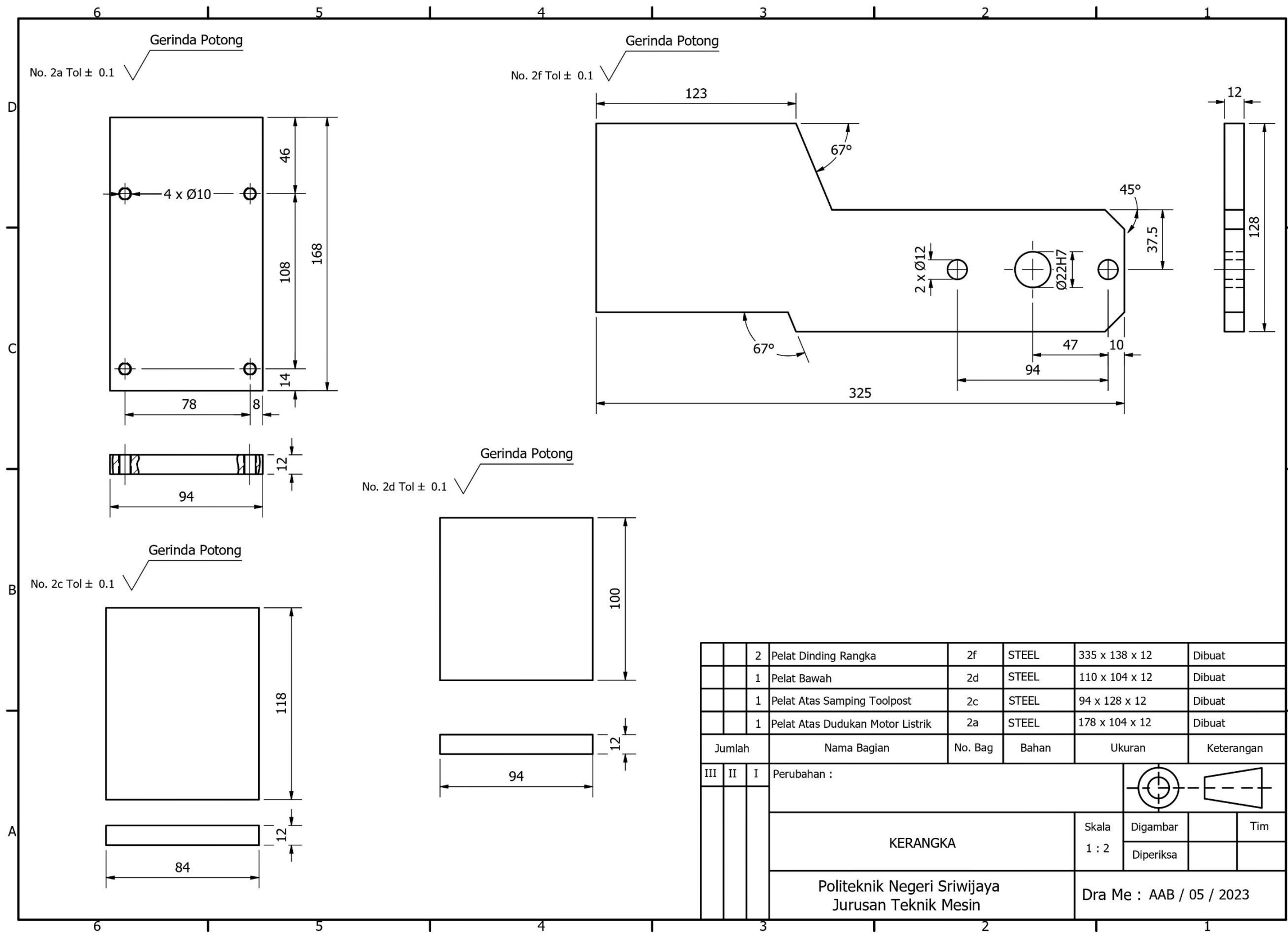

		2	Pelat Dinding Rangka	2f	STEEL	335 x 138 x 12	Dibuat	
		1	Pelat Bawah	2d	STEEL	110 x 104 x 12	Dibuat	
		1	Pelat Atas Samping Toolpost	2c	STEEL	94 x 128 x 12	Dibuat	
		1	Pelat Atas Dudukan Motor Listrik	2a	STEEL	178 x 104 x 12	Dibuat	
		Jumlah	Nama Bagian	No. Bag	Bahan	Ukuran	Keterangan	
III	II	I	Perubahan :					
			KERANGKA			Skala 1 : 2		Digambar Diperiksa
Politeknik Negeri Sriwijaya Jurusan Teknik Mesin						Dra Me : AAB / 05 / 2023		

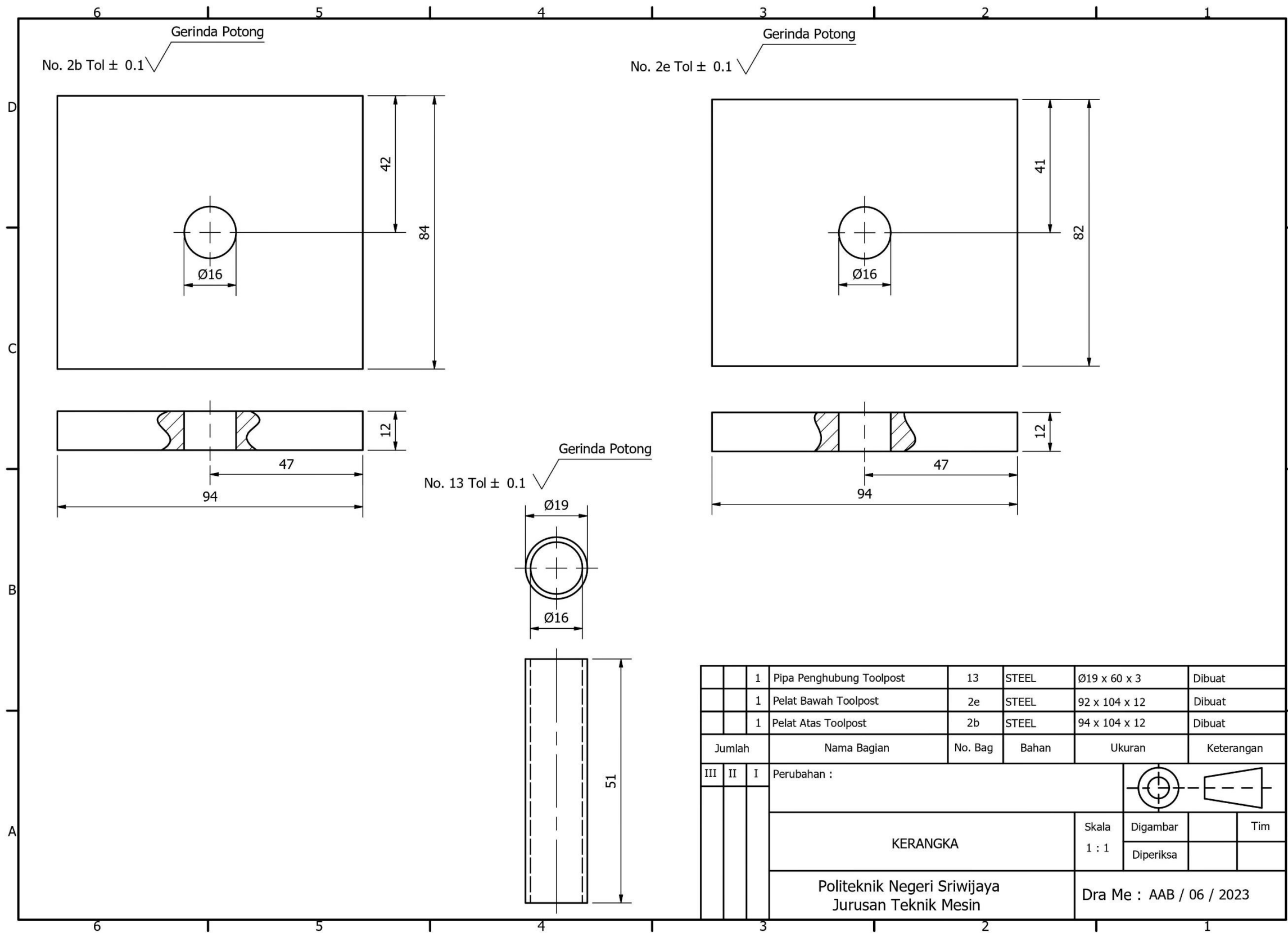

No. 2b Tol ± 0.1

No. 2e Tol ± 0.1

No. 13 Tol ± 0.1

		1	Pipa Penghubung Toolpost	13	STEEL	Ø19 x 60 x 3	Dibuat	
		1	Pelat Bawah Toolpost	2e	STEEL	92 x 104 x 12	Dibuat	
		1	Pelat Atas Toolpost	2b	STEEL	94 x 104 x 12	Dibuat	
	Jumlah		Nama Bagian	No. Bag	Bahan	Ukuran	Keterangan	
III	II	I	Perubahan :					Tim
			KERANGKA					
						Skala 1 : 1	Digambar	
							Diperiksa	
Politeknik Negeri Sriwijaya Jurusan Teknik Mesin						Dra Me : AAB / 06 / 2023		

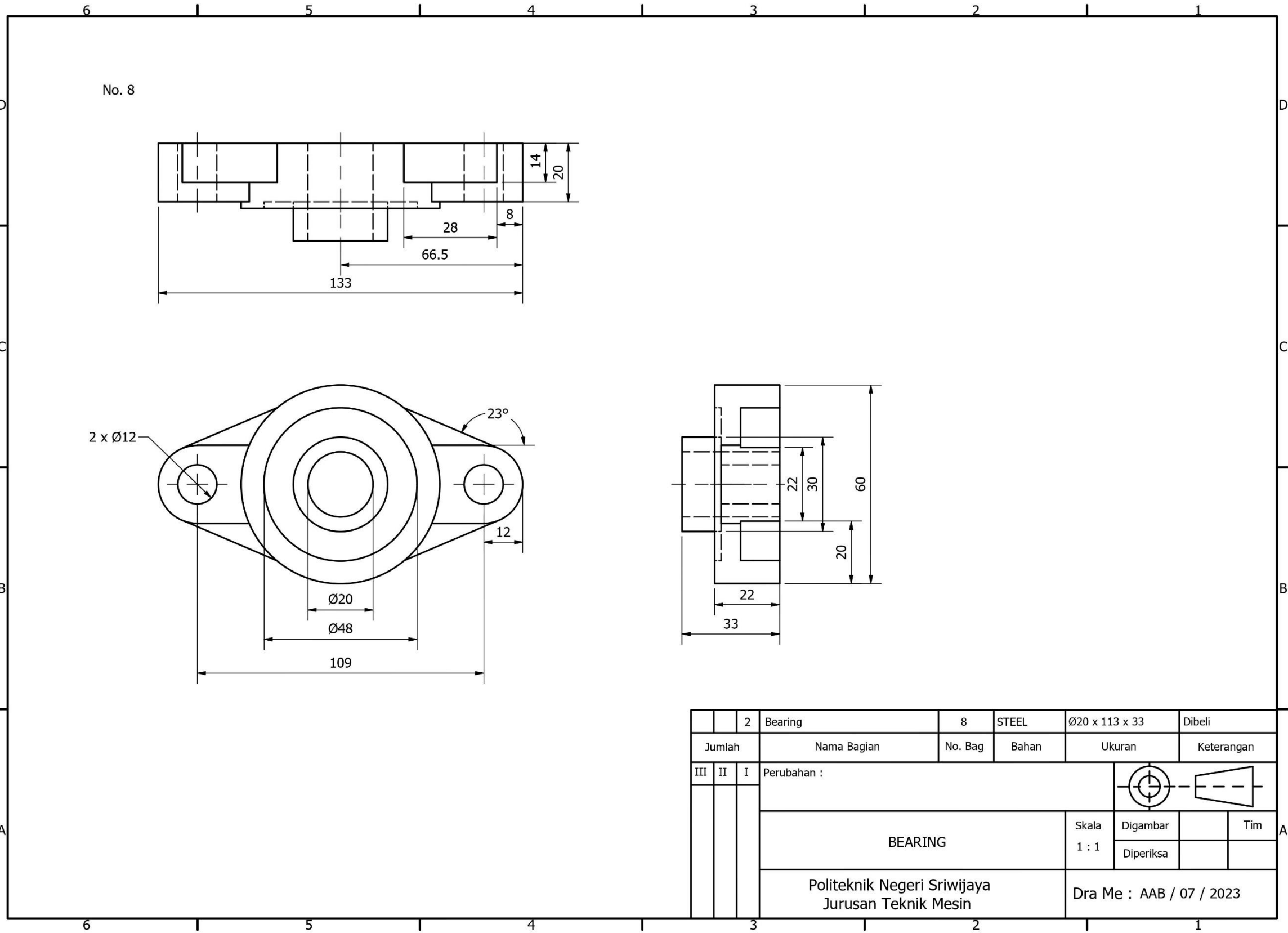

		2	Bearing	8	STEEL	Ø20 x 113 x 33	Dibeli	
Jumlah	Nama Bagian			No. Bag	Bahan	Ukuran	Keterangan	
III	II	I	Perubahan :					
			BEARING			Skala 1 : 1	Digambar	Tim
			Politeknik Negeri Sriwijaya Jurusan Teknik Mesin			Dra Me : AAB / 07 / 2023		

### PANJANG V-BELT STANDAR

Nomor nominal		Nomor nominal		Nomor nominal		Nomor nominal	
(inch)	(mm)	(inch)	(mm)	(inch)	(mm)	(inch)	(mm)
10	254	45	1143	80	2032	115	2921
11	279	46	1168	81	2057	116	2946
12	305	47	1194	82	2083	117	2972
13	330	48	1219	83	2108	118	2997
14	356	49	1245	84	2134	119	3023
15	381	50	1270	85	2159	120	3048
16	406	51	1295	86	2184	121	3073
17	432	52	1321	87	2210	122	3099
18	457	53	1346	88	2235	123	3124
19	483	54	1372	89	2261	124	3150
20	508	55	1397	90	2286	125	3175
21	533	56	1422	91	2311	126	3200
22	559	57	1448	92	2337	127	3226
23	584	58	1473	93	2362	128	3251
24	610	59	1499	94	2388	129	3277
25	635	60	1524	95	2413	130	3302
26	660	61	1549	96	2438	131	3327
27	686	62	1575	97	2464	132	3353
28	711	63	1600	98	2489	133	3378
29	737	64	1626	99	2515	134	3404
30	762	65	1651	100	2540	135	3429
31	787	66	1676	101	2565	136	3454
32	813	67	1702	102	2591	137	3480
33	838	68	1727	103	2616	138	3505
34	864	69	1753	104	2642	139	3531
35	889	70	1778	105	2667	140	3556
36	914	71	1803	106	2692	141	3581
37	940	72	1829	107	2718	142	3607
39	965	73	1854	108	2743	143	3632
39	991	74	1880	109	2769	144	3658
40	1016	75	1905	110	2794	145	3683
41	1041	76	1930	111	2819	146	3708
42	1067	77	1956	112	2845	147	3734
43	1092	78	1981	113	2870	148	3759
44	1118	79	2007	114	2896	149	3785



## KECEPATAN POTONG DAN SUDUT UTAMA BOR

MATERIAL	CUTTING SPEEDS 1. (METERS/MINUTE) (FEET/MINUTE)		POINT ANGLE
	MPM	FPM	
Aluminum And Alloys	61.00 - 91.50	200 - 300	90 - 130 deg
Armor Plate	12.20 - 18.25	40 - 50	135 - 140 deg
Brass	61.00 - 91.50	200 - 300	118 - 118 deg
Bronze	61.00 - 91.50	200 - 300	110 - 118 deg
Bronze, High Tensile	21.35 - 45.75	70 - 150	100 - 110 deg
Cast Iron, Soft	30.50 - 45.75	100 - 150	90 - 100 deg
Cast Iron, Medium	21.35 - 30.50	70 - 100	100 - 110 deg
Cast Iron, Hard	21.35 - 30.50	70 - 100	100 - 118 deg
Cast Iron, Chilled	9.15 - 12.20	30 - 40	118 - 135 deg
Copper	61.00 - 91.50	200 - 300	100 - 118 deg
Copper Graphite Alloy (Carbon Drills)	18.30 - 21.35	60 - 70	**_**
Glass (Carbon Drills)	6.10 - 9.15	20 - 30	**_**
Iron, Malleable	15.25 - 27.45	50 - 90	90 - 100 deg
Magnesium And Alloys	76.25 - 122.0	250 - 400	70 - 118 deg
Monel Nickel	4.15 - 15.28	30 - 50	118 - 125 deg
Nickel Alloys	12.20 - 18.30	40 - 60	135 - 140 deg
Plastic, Hot Set	30.50 - 91.50	100 - 300	60 - 90 deg
Plastic, Cold Set	30.50 - 91.50	100 - 300	118 - 135 deg
Steel, Low Carbon, 0.2-0.3c	24.40 - 33.55	80 - 110	110 - 118 deg
Steel, Medium Carbon 0.4-0.5c	21.35 - 24.40	70 - 80	118 - 125 deg
Steel (High Carbon 1.2c)	15.25 - 18.30	50 - 60	118 - 145 deg
Steel, Forged	15.25 - 18.30	50 - 60	118 - 145 deg
Steel, Alloy	15.25 - 21.35	50 - 70	118 - 125 deg
Steel, Alloy 300 To 400 Brinell	6.10 - 9.15	20 - 30	130 - 140 deg
Steel, Stainless, Free Machining	9.15 - 24.40	30 - 80	110 - 118 deg
Steel, Stainless, Hard	4.57 - 15.25	15 - 50	118 - 135 deg
Steel, Manganese	3.66 - 4.57	12 - 15	140 - 150 deg
Stone (Carbide Drills)	7.63 - 9.15	25 - 30	**_**
Wood	91.50 - 122.2	300 - 400	60 - 70 deg



## DAFTAR BIAYA SEWA PERALATAN PER JAM KERJA

No.	URAIAN	KODE	HP	KAP.	HARGA	BIAYA	
						ALAT	SEWA
						ALAT/JAM	KETERANGAN
						(di luar PPN)	
53	CONCRETE PAN MIXER	E43	15.4	500.0 Liter	20,988,000		91,973.63
54	CONCRETE BREAKER	E44	290.0	20.0 m3/jam	900,000,000		751,370.86
55	ASPHALT TANKER	E45	190.0	4,000.0 liter	500,000,000		489,878.52
56	CEMENT TANKER	E46	190.0	4,000.0 liter	500,000,000		489,878.52
57	VIBRATING RAMMER	E48	4.2	80.0 KG	8,190,000		70,063.39
58	TRUK MIXER (AGITATOR)	E49	254.8	5.0 M3	1,002,350,000		704,934.60
59	BORE PILE MACHINE	E50	125.0	80.0 CM	1,170,000,000		449,762.45
60	CRANE ON TRACK 75-100 TON	E51	200.0	75.0 Ton	10,540,000,000		2,287,379.17
61	BLENDING EQUIPMENT	E52	50.0	30.0 Ton	500,000,000		221,552.46
62	BAR BENDER	E53	3.0	0.0 -	82,500,000		87,806.80
63	BAR CUTTER	E54	3.0	0.0 -	82,500,000		87,806.80
64	BREAKER	E55	170.0	15.0 m3/jam	1,650,000,000		663,833.13
65	GROUTING PUMP	E56	100.0	15.0 Ton	24,000,000		248,679.26
66	JACK HIDROLIC	E57	10.0	- -	12,000,000		81,659.45
67	MESIN LAS	E58	33.0	2.0 Kw	26,800,000		119,212.03
68	PILE DRIVER LEADER, 75 kw	E59	70.0	75.0 kw	5,850,000,000		1,357,510.74
69	PILE HAMMER	E60	75.0	2.0 Ton	3,000,000,000		1,092,695.20
70	PILE HAMMER, 2,5 Ton	E61	75.0	2.5 Ton	4,000,000,000		997,293.84
71	STRESSING JACK	E62	89.0	15.0 Ton	300,000,000		273,060.27
72	WELDING MACHINE, 300 A	E63	5.0	0.0 -	35,530,000		78,264.28
73	WATER JET BLASTING	E64	6.5	100.0 Liter	16,000,000		76,961.63
74	MESIN POTONG RUMPUT	E65	1.0	- -	3,500,000		63,799.75
75	PONTON + TUG BOAT, 40 TON, 80 HP	E66	36.0	50.0 Ton	2,500,000,000		594,253.48
76	SILICON SEAL PUMP	E67	0.0	0.0 -	23,500		61,229.72
77	POMPA UNTUK EPOXY	E68	0.0	0.0 -	10,000,000		66,230.94
78	GERINDATANGAN GWS 750-1000 4" 1 HP	E69	2.2	0.0 -	10,000,000		69,550.19
79	HAND MIXER	E70	7.5	0.0 -	3,000,000		74,038.65
80	MESIN BOR	E71	0.5	0.0 -	575,000		62,262.16
81	CRAWLER CRANE 25 TON	E72	191.0	25.0 Ton	2,640,000,000		876,988.98
82	CRAWLER CRANE 55 TON	E73	220.0	55.0 Ton	3,808,000,000		1,136,209.69
83	KUNCI TORSI 200-1000 N.M	E74	0.0	1.0 buah baut	15,000,000.00		68,736.60
84	POMPA + MIXER EPOXY, 810 Watt	E75	1.1	0.8 l/mnt	7,000,000.00		66,357.00
85	CONCRETE CUTTER (0.5-0.7 m/menit)	E76	13.0	39.6 m/menit	28,000,000.00		93,862.79
86	SAND BLASTING	E77	75.0	10.0 m2/jam	7,500,000.00		178,134.37
87	MOBILE CRANE 1 TON	E78	190.0	1.0 Ton	900,000,000.00		568,145.86
88	DRUM MIXER	E79	20.0	4.0 Ton/jam	600,000,000.00		392,073.39
89	CONCRETE BATCHING PLANT	E80	120.0	25.0 M3/jam	1,400,000,000		597,091.39
90	STAMPER	E81	22.0	80.0 m2/jam	30,000,000.00		109,446.07
91	JACK HIDROLIK JEMBATAN	E82	22.0	50.0 Ton	75,000,000.00		114,467.51
92	HYDROLIC PUMP	E83	22.0	30.0 Mpa	16,000,000.00		98,690.61
93	MANIFOLD GAUGE	E84	0.0	1.0 Mpa	5,000,000.00		63,725.29
94	THERMOPLASTIC ROAD MARKING MACHINE	E85	5.5	1,300.0 m/jam	120,000,000.00		101,606.36
95	COLD PAINT SPRAY MACHINE	E86	5.5	1,300.0 m/jam	70,000,000.00		88,236.11
96	TRAILER 44 TON	E87	350.0	44.0 Ton	1,225,050,000		916,866.69
97	TRUCK 2 TON	E88	107.8	2.0 Ton	220,200,000		287,663.48
98	DROP HAMMER 2.5 TON	E91	120.0	2.5 Ton	2,000,000,000		633,975.69
99	DIESEL HAMMER SINGLE ACTING 2.5 TON	E92	120.0	2.5 Ton	2,200,000,000		669,264.30
100	DIESEL HAMMER DOUBLE ACTING 2.5 TON	E93	120.0	2.5 Ton	2,500,000,000		722,197.21
101	HOT COMPRESSOR AIR LANCE (HC-A) 10000 C	E94	5.0	5,000.0 CPM(L/m)	56,000,000		96,826.73
102	PRE HEATER/BOILER	E95	10.0	5,000.0 CPM(L/m)	70,000,000		111,386.32
103	MACHINE BEAM LAUNCHER CRANE 100 TON	E96	0.0	100.0 Ton	1,600,000,000		343,528.48
104	MACHINE BEAM LAUNCHER CRANE 300 TON	E97	0.0	300.0 Ton	2,400,000,000		484,682.90

## TOLERANSI SUAIAI

Tingkat suaian	Lubang	Poros	Keadaan suaian
Suaian sangat luas	H11	c11	Suaian longgar
	H9	d10	
		e9	
Suaian luas	H8	f7	
	H7	g6	
		h6	
k6			
Suaian geser			Suaian transisi
Suaian puntir		n6	
Suaian paksa			Suaian sesak
Suaian kempa ringan		p6	
Suaian kempa berat		s6	





Lubang

Poros

  
H11

  
H9

  
H8

  
H7

  
H7

  
H7

  
H7 k6

  
H7 n6

  
H7 p6

  
H7 s6

UK Nominal		Longgar						Transmisi		Sesak											
		Suaian Sangat Luas			Suaian Luas			Suaian Geser	Suaian Puntir	Suaian Paksa	Suaian Kp. ringan	Suaian Kp. berat									
		Toleransi	Toleransi	Toleransi	Toleransi	Toleransi	Toleransi	Toleransi	Toleransi	Toleransi	Toleransi	Toleransi									
Lebih besar dari	Sampai dengan	H11	c11	H9	d10	H9	e9	H8	f7	H7	g6	H7	h6	H7	k6	H7	n6	H7	p6	H7	s6
mm	mm	+60	-60	+25	-20	+25	-14	+14	-6	+10	-2	+10	-6	+10	+6	+10	+10	+10	+12	+10	+20
-	3	0	-120	0	-60	0	-39	0	-16	0	-8	0	0	0	0	0	+14	0	+6	0	+14
3	6	+75	-70	+30	-30	+30	-20	+18	-10	+12	-4	+12	+8	+12	+9	+12	+16	+12	+20	+12	+27
		0	-145	0	-78	0	-50	0	-22	0	-12	0	0	0	+1	0	+8	0	+12	0	+19
6	10	+90	-80	+36	-40	+36	-25	+22	-12	+15	-5	+15	-9	+15	+10	+15	+19	+15	+24	+15	+32
		0	-170	0	-78	0	-81	0	-26	0	-14	0	0	0	+1	0	+10	0	+15	0	+23
10	18	+110	-95	+43	-50	+43	-32	+27	-16	+18	-6	+18	-11	+18	+12	+18	+29	+18	+29	+18	+39
		0	-205	0	-129	0	-75	0	-34	0	-17	0	0	0	+1	0	+12	0	+18	0	+28
18	30	+130	-110	+52	-65	+52	-40	+33	-20	-21	-7	+21	-13	+21	+15	+21	+28	+21	+35	+21	+48
		0	-240	0	-149	0	-92	0	-41	0	-20	0	0	0	+12	0	+15	0	+22	0	+35
30	40	+160	-120	+62	-80	+62	-50	+39	-25	+25	-9	+25	-16	+25	+18	+25	+33	+25	+42	+25	+59
		0	-240	0	-180	0	-112	0	-50	0	-25	0	0	0	+2	0	+17	0	26	0	+43
40	50	+160	-130	0	-180	0	-112	0	-50	0	-25	0	0	0	+2	0	+17	0	26	0	+43
		0	-290	0	-240	0	-190	0	-140	0	-190	0	-140	0	-190	0	-140	0	-190	0	-140
50	65	+190	-140	+74	-100	+74	-60	+46	-30	+30	-10	+30	-19	+30	+21	+30	+39	+30	+51	+30	+72
		0	-330	0	-220	0	-134	0	-60	0	-29	0	0	0	+2	0	+20	0	+32	0	+59
65	80	+190	-150	0	-220	0	-134	0	-60	0	-29	0	0	0	+2	0	+20	0	+32	0	+59
		0	-340	0	-240	0	-190	0	-140	0	-190	0	-140	0	-190	0	-140	0	-190	0	-140
80	100	+220	-170	+67	-120	+67	-72	+54	-36	+35	-12	+35	+25	+35	+25	+35	+45	+35	+59	+35	+97
		0	-390	0	-260	0	-159	0	-71	0	-34	0	0	0	+3	0	+23	0	+37	0	+71
100	120	+220	-180	0	-260	0	-159	0	-71	0	-34	0	0	0	+3	0	+23	0	+37	0	+71
		0	-400	0	-260	0	-159	0	-71	0	-34	0	0	0	+3	0	+23	0	+37	0	+71
120	140	+250	-210	+100	-145	+100	-84	+63	-43	+40	-14	+40	-25	+40	+08	+40	+52	+40	+68	+40	+117
		0	-450	0	-260	0	-159	0	-71	0	-34	0	0	0	+3	0	+23	0	+37	0	+71
140	160	+250	-210	0	-260	0	-159	0	-71	0	-34	0	0	0	+3	0	+23	0	+37	0	+71
		0	-460	0	-260	0	-159	0	-71	0	-34	0	0	0	+3	0	+23	0	+37	0	+71
160	180	+250	+230	0	-305	0	-185	0	-83	0	-39	0	0	0	+3	0	+27	0	+43	+40	+125
		0	-480	0	-260	0	-159	0	-71	0	-34	0	0	0	+3	0	+23	0	+37	0	+71
180	200	+290	-240	+115	-170	+115	-100	+72	-50	+46	-15	+46	-29	+46	+33	+46	+60	+46	+79	+46	+151
		0	-536	0	-260	0	-159	0	-71	0	-34	0	0	0	+3	0	+23	0	+37	0	+71
200	225	+290	-260	0	-260	0	-159	0	-71	0	-34	0	0	0	+3	0	+23	0	+37	0	+71
		0	-550	0	-260	0	-159	0	-71	0	-34	0	0	0	+3	0	+23	0	+37	0	+71
225	250	+290	-280	0	-355	0	-215	0	-96	0	-44	0	0	0	+4	0	+31	0	+50	+46	+169
		0	-570	0	-260	0	-159	0	-71	0	-34	0	0	0	+3	0	+23	0	+37	0	+71

Keterangan :  
 Satuan toleransi, dalam micronmeter (mikron)  
 Biasanya ditulis dalam simbol  $\mu\text{m}$ .  $1 \mu\text{m} = 0,001 \text{ mm}$

## DATA BANTALAN UFCL

Dimensional Drawing

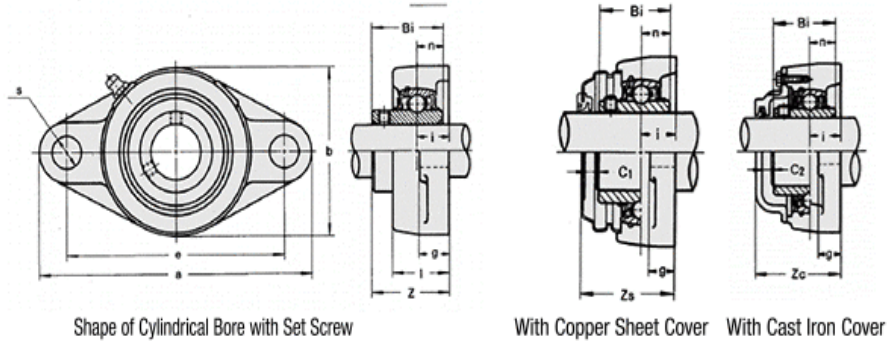

Unit Bearing Number	Shaft Diameter (mm)	Main Dimension (mm)											Nominal Attaching Bolt Size	Bearing		With Copper Sheet Cover	With Cast Iron Cover
		a	e	g	l	s	b	Z	Bi	n	Zs	Zc		Basic Load Rating (kN)		Penetrating Cover C Single Blank Cover E	Penetrating Cover C Single Blank Cover CE
														Cr	Cor	UCFL	CUCFL
UCFL 201	12	113	90	12	25.5	12	60	33.3	31	12.7	43	46	M10	12.8	6.6	201C(E)	201C(CE)
UCFL 202	15	113	90	12	25.5	12	60	33.3	31	12.7	43	46	M10	12.8	6.6	202C(E)	202C(CE)
UCFL 203	17	113	90	12	25.5	12	60	33.3	31	12.7	43	46	M10	12.8	6.6	203C(E)	203C(CE)
UCFL 204	20	113	90	12	25.5	12	60	33.3	31	12.7	43	46	M10	12.8	6.6	204C(E)	204C(CE)
UCFL 205	25	130	99	14	27	16	68	35.7	34	14.3	47	51	M14	14	7.9	205C(E)	205C(CE)
UCFL X05		141	117	13	30	12	83	40.2	38.1	15.9	51	—	M10	19.6	11.3	X05C(E)	—
UCFL 305		150	113	13	29	19	80	39	38	15	—	55	M16	21.3	10.9	—	305C(CE)
UCFL 206	30	148	117	14	31	16	80	40.2	38.1	15.9	49	55	M14	19.6	11.3	206C(E)	206C(CE)
UCFL X06		156	130	14	34	16	95	44.4	42.9	17.5	54	—	M14	25.9	15.4	X06C(E)	—
UCFL 306		180	134	15	32	23	90	44	43	17	—	60	M20	26.8	15	—	306C(CE)
UCFL 207	35	161	130	16	34	16	90	44.4	42.9	17.5	54	59	M14	25.9	15.4	207C(E)	207C(CE)
UCFL X07		171	144	14	38	16	105	51.2	49.2	19	63	—	M14	29.3	17.9	X07C(E)	—
UCFL 307		185	141	16	36	23	100	49	48	19	—	65	M20	33.5	19.2	—	307C(CE)
UCFL 208	40	175	144	16	36	16	100	51.2	49.2	19	61	66	M14	29.3	17.9	208C(E)	208C(CE)
UCFL X08		179	148	14	40	16	111	52.2	49.2	19	63	—	M14	33	20.5	X08C(E)	—
UCFL 308		200	158	17	40	23	112	56	52	19	—	73	M20	40.5	23.9	—	308C(CE)
UCFL 209	45	188	148	18	38	19	108	52.2	49.2	19	63	67	M16	33	20.5	209C(E)	209C(CE)
UCFL X09		189	157	14	40	16	116	55.6	51.6	19	67	—	M14	35.5	23.2	X09C(E)	—
UCFL 309		230	177	18	44	25	125	60	57	22	—	78	M22	51.5	29.5	—	309C(CE)
UCFL 210	50	197	157	18	40	19	115	54.6	51.6	19	66	71	M16	35.5	23.2	210C(E)	210C(CE)
UCFL X10		216	184	20	44	19	133	59.4	55.6	22.2	70	—	M16	43	29.4	X10C(E)	—
UCFL 310		240	187	19	48	25	140	67	61	22	—	85	M22	61.5	38.2	—	310C(CE)
UCFL 211	55	224	184	20	43	19	130	58.4	55.6	22.2	69	75	M16	43	29.4	211C(E)	211C(CE)
UCFL 311		250	198	20	52	25	150	71	66	25	—	90	M22	71.5	44.8	—	311C(CE)
UCFL 212	60	250	202	20	48	23	140	68.7	65.1	25.4	80	86	M20	52.5	36.1	212C(E)	212C(CE)
UCFL 312		270	212	22	56	31	160	78	71	26	—	98	M27	81.5	52	—	312C(CE)
UCFL 213	65	258	210	24	50	23	155	69.7	65.1	25.4	81	89	M20	57.5	40	213C(E)	213C(CE)
UCFL 313		295	240	25	58	31	175	78	75	30	—	103	M27	92.5	59.4	—	313C(CE)
UCFL 214	70	265	216	24	54	23	160	75.4	74.6	30.2	—	98	M20	62	44	—	214C(CE)
UCFL 314		315	250	28	61	35	185	81	78	33	—	106	M30	104	68	—	314C(CE)
UCFL 215	75	275	225	24	56	23	165	78.5	77.8	33.3	—	102	M20	66	48.2	—	215C(CE)
UCFL 315		320	260	30	66	35	195	89	82	32	—	114	M30	114	76.9	—	315C(CE)
UCFL 216	80	290	233	24	58	25	180	83.3	82.6	33.3	—	107	M22	72.5	53	—	216C(CE)
UCFL 316		355	285	32	68	38	210	90	86	34	—	115	M33	123	86.4	—	316C(CE)
UCFL 217	85	305	248	26	63	25	190	87.6	85.7	34.1	—	111	M22	83.5	61.8	—	217C(CE)
UCFL 317		370	300	32	74	38	220	100	96	40	—	126	M33	132	96.5	—	317C(CE)
UCFL 218	90	320	265	26	68	25	205	96.3	96	39.7	—	122	M22	95.5	71.4	—	218C(CE)
UCFL 318		385	315	36	76	38	235	100	96	40	—	128	M33	143	107.2	—	318C(CE)
UCFL 319	95	405	330	40	94	41	250	121	103	41	—	149	M36	153	118.4	—	319C(CE)
UCFL 320	100	440	360	40	94	44	270	125	108	42	—	154	M39	173	140.4	—	320C(CE)
UCFL 321	105	440	360	40	94	44	270	127	112	44	—	156	M39	183	153.1	—	321C(CE)

\* Please inquire about dimensions greater than UCF322. Grease nipples with a bore diameter number of 13 and under are 1/4-28UNF; those with a bore diameter of 14 and above are PF1/8.

Kami yang bertanda tangan dibawah ini :

**Pihak Pertama**

Nama : ALBY KALHAWAT  
 NIM : 062030200792  
 Jurusan/Program Studi : TEKNIK MESIN / D3-TEKNIK MESIN

**Pihak Kedua**

Nama : DR. ZAINUDDIN, M.T.  
 NIP : 197810081986031005  
 Jurusan/Program Studi : TEKNIK MESIN / D3-TEKNIK MESIN

Pada hari ini FRBN tanggal 8-3-2023 telah sepakat untuk melakukan konsultasi bimbingan Laporan Akhir/Tugas akhir.

Isi kesepakatan :

1. Konsultasi bimbingan sekurang-kurangnya 1 (satu) kali dalam 1 (satu) minggu.
2. Pelaksanaan bimbingan pada setiap hari SELASA pukul 10.00 tempat di Jurusan T.Mesin Polsri.

Demikianlah kesepakatan ini dibuat dengan penuh kesadaran guna kelancaran penyelesaian Laporan Akhir.

**Pihak Pertama,**

  
 ( ALBY KALHAWAT )  
 NIM.....062030200792

Palembang, 8 MARET 2023

**Pihak Kedua,**

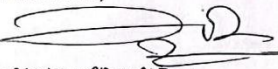
  
 ( DR. ZAINUDDIN, M.T. )  
 NIP.....197810081986031005

Mengetahui,  
 Ketua Jurusan / Program Studi

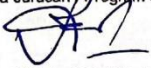
  
 ( Ir. FAUZIL EFFENDI, M.T. )  
 NIP.....196709011989031005

Kami yang bertanda tangan dibawah ini :

**Pihak Pertama**

Nama : ALBY KALIAWAN  
 NIM : 0620302079  
 Jurusan/Program Studi : TEKNIK MESIN / D3-TEKNIK MESIN

**Pihak Kedua**

Nama : DRS. JOEGENG WITAJAH, S.T., M.T.  
 NIP : 196101061980031003  
 Jurusan/Program Studi : TEKNIK MESIN / D3-TEKNIK MESIN

Pada hari ini tanggal 01-03-2023 telah sepakat untuk melakukan konsultasi bimbingan Laporan Akhir/Tugas akhir.  
 Isi kesepakatan :

1. Konsultasi bimbingan sekurang-kurangnya 1 (satu) kali dalam 1 (satu) minggu.
2. Pelaksanaan bimbingan pada setiap hari RAU pukul 10.00 tempat di Jurusan T.Mesin Polsri.

Demikianlah kesepakatan ini dibuat dengan penuh kesadaran guna kelancaran penyelesaian Laporan Akhir.

**Pihak Pertama,**

  
 (...ALBY KALIAWAN...)  
 NIM...0620302079

Palembang, 01 MARET 2023

**Pihak Kedua,**

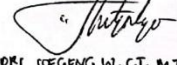
  
 (...DRS. JOEGENG WITAJAH, S.T., M.T....)  
 NIP...196101061980031003

Mengetahui,

Ketua Jurusan / Program Studi

  
 (...Ir. SANJUL EFFENDI, M.T....)  
 NIP...196709121980031005

**KEMENTERIAN PENDIDIKAN, KEBUDAYAAN, RISET DAN TEKNOLOGI**  
**POLITEKNIK NEGERI SRIWIJAYA**  
 Jalan Srijaya Negara, Palembang 30139  
 Telp. 0711-353414 Fax. 0711-355918  
 Website : www.polisriwijaya.ac.id E-mail : info@polsri.ac.id



**BIMBINGAN LAPORAN AKHIR/TUGAS AKHIR**

Nama : ALBBY KALYAWAN  
 NIM : 062030200792  
 Jurusan/Program Studi : TEKNIK MESIN / D3 - TEKNIK MESIN  
 RANCANG BAHUUN GELOMPOK TILINDUKI PERAGAI ALAT BANTU  
 JUDUL LAPORAN LA/TA : PENGAJUAN... PARA... RENCANA... PERAWA...  
 Pembimbing : Drs. ZAHMUDIN, M.T.

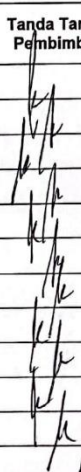
No.	Tanggal	Uraian Bimbingan	Tanda Tangan Pembimbing
1.	7 MARET 2023	KONSULTASI JUDUL DAN ALAT YANG DI BUAT	
2.	14 MARET 2023	PENGJAWAN JUDUL DAN ACC JUDUL	
3.	28 MARET 2023	PENGJAWAN RANCANGAN GAMBAR DAN REVISI	
4.	4 APRIL 2023	PENGJAWAN RANCANGAN GAMBAR DAN REVISI	
5.	10 APRIL 2023	PENGJAWAN RANCANGAN GAMBAR DAN ACC	
6.	16 MEI 2023	PENGJAWAN BAB 1 & 2 DAN REVISI LAMPAK ISELAWAN G	
7.	23 MEI 2023	PENGJAWAN BAB 1 & 2 DAN ACC	
8.	26 JUNI 2023	PENGJAWAN BAB 3 DAN REVISI PERHITUNGAN KOMPONEN	
9.	11 JULI 2023	PENGJAWAN BAB 3 DAN ACC	
10.	10 JULI 2023	PENGJAWAN BAB 4 & 5 DAN REVISI PENGUJIAN	
11.	15 JULI 2023	PENGJAWAN BAB 4 & 5 DAN ACC	
12.	2 AGUSTUS 2023	ACC LAPORAN DAN REKOMENDASI UJIAN LA/TA	

Mengetahui,  
 Ketua Jurusan/KPS,  
  
 (Dr. JAHUL EFFENDI, M.T.)  
 NIP. 196309191989031005

Palembang, 3 AGUSTUS 2023...  
 Pembimbing Akademik  
  
 (RISKY BILLIAN Y.M.T.)  
 NIP. 19970811107011022

**Catatan:**  
 Ketua Jurusan/Ketua Program Studi & PA harus memeriksa jumlah pelaksanaan bimbingan sesuai yang dipersyaratkan dalam Pedoman Laporan Akhir & Tugas Akhir minimum sepuluh kali bimbingan sebelum menandatangani lembar bimbingan ini. Lembar pembimbingan LA/TA ini harus dilampirkan dalam Laporan LA/TA.





KEMENTERIAN PENDIDIKAN, KEBUDAYAAN, RISET DAN TEKNOLOGI  
**POLITEKNIK NEGERI SRIWIJAYA**  
 Jalan Srijaya Negara, Palembang 30139  
 Telp. 0711-353414 Fax. 0711-355918  
 Website : www.polisriwijaya.ac.id E-mail : info@polsri.ac.id



**BIMBINGAN LAPORAN AKHIR/TUGAS AKHIR**

Nama : ALBY KALNIWAH  
 NIM : 062070200392  
 Jurusan/Program Studi : TEKNIK MESIN / 03-TEKNIK MESIN  
 Judul Laporan LA/TA : RANCANG BANGUN GERAKA SUDURUT JERAGAI MAT BANTU  
 PENGHILAUH PADA PROSES PEMBUNGTAN  
 Pembimbing : DR. SOELENG WITJAHUO, S.T., M.T.

No.	Tanggal	Uraian Bimbingan	Tanda Tangan Pembimbing
1.	0 MARET 2023	KONULTASI JUDUL DAN ALAT YANG DIUAT	<i>skt</i>
2.	15 MARET 2023	PENGAWAN JUDUL DAN ACC JUDUL	<i>skt</i>
3.	5 APRIL 2023	PENGAWAN RANCANGAN GAMBAR DAN REVISI	<i>skt</i>
4.	12 APRIL 2023	PENGAWAN RANCANGAN GAMBAR DAN REVISI	<i>skt</i>
5.	17 MEI 2023	PENGAWAN RANCANGAN GAMBAR DAN ACC	<i>skt</i>
6.	7 JUNI 2023	PENGAWAN BAB 1 & 2 DAN REVISI	<i>skt</i>
7.	14 JUNI 2023	PENGAWAN BAB 1 & 2 DAN ACC	<i>skt</i>
8.	5 JULI 2023	PENGAWAN BAB 3 DAN REVISI TERKININGAT KOMPONEN	<i>skt</i>
9.	12 JULI 2023	PENGAWAN BAB 3 DAN ACC	<i>skt</i>
10.	10 JULI 2023	PENGAWAN BAB 4 & 5 DAN REVISI	<i>skt</i>
11.	25 JULI 2023	PENGAWAN BAB 4 & 5 DAN ACC	<i>skt</i>
12.	2 AGUSTUS 2023	ACC LAPORAN DAN REKOMENDASI UJIAN LA/TA	<i>skt</i>

Mengetahui,  
 Ketua Jurusan/KPS,

*(Signature)*  
 (Ir. JAKUL EFFENDI, M.T.)  
 NIP. 19630911980031005

Palembang, 03 AGUSTUS 2023  
 Pembimbing Akademik

*(Signature)*  
 (RIKY BELLIAN Y, M.T.)  
 NIP. 19920111202011012

Catatan:  
 Ketua Jurusan/Ketua Program Studi & PA harus memeriksa jumlah pelaksanaan bimbingan sesuai yang dipersyaratkan dalam Pedoman Laporan Akhir & Tugas Akhir minimum sepuluh kali bimbingan sebelum menandatangani lembar bimbingan ini. Lembar pembimbingan LA/TA ini harus dilampirkan dalam Laporan LA/TA.

	<b>KEMENTERIAN PENDIDIKAN, KEBUDAYAAN, RISET DAN TEKNOLOGI</b> <b>POLITEKNIK NEGERI SRIWIJAYA</b> Jalan Srijaya Negara, Palembang 30139 Telp. 0711-353414 Fax. 0711-355918 Website : www.polisriwijaya.ac.id E-mail : info@polsri.ac.id	
	<b>REKOMENDASI UJIAN LAPORAN AKHIR/TUGAS AKHIR</b>	

Pembimbing Laporan Akhir/Tugas Akhir memberikan rekomendasi kepada,

Nama : ALBY KALIAWAN  
 NIM : 062030201902  
 Jurusan/Program Studi : TEKNIK MESIN / D3-TEKNIK MESIN  
 Judul Laporan : PANCAHO BANGUN GERINDA JILINDRI SEBAGAI  
ALAT BAHAN PEMERIKSAAN PADA PROSES  
PEMANGKATAN

Mahasiswa tersebut telah memenuhi persyaratan dan dapat mengikuti Ujian Laporan Akhir/Tugas Akhir (LATA) pada Tahun Akademik ...2023...

Diketahui  
 Pembimbing Akademik



(RIZKY RAULIAN Y, M.T.)  
 NIP ..19910811200111012

Palembang, ..2/8..-2023  
 Pembimbing LATA



(DR. FANUDIN, M.T.)  
 NIP ..19581008196503005



KEMENTERIAN PENDIDIKAN, KEBUDAYAAN, RISET DAN TEKNOLOGI

POLITEKNIK NEGERI SRIWIJAYA

Jalan Srijaya Negara, Palembang 30139

Telp. 0711-353414 Fax. 0711-355918

Website : www.polsriwijaya.ac.id E-mail : info@polsri.ac.id



**REKOMENDASI UJIAN LAPORAN AKHIR/TUGAS AKHIR**

Pembimbing Laporan Akhir/Tugas Akhir memberikan rekomendasi kepada,

Nama : ALBY KALIMAWAN

NIM : 062030200792

Jurusan/Program Studi : TEKNIK MESIN / D3- TEKNIK MESIN

Judul Laporan : RANCANG BANGUN GERINDA SINDRIF SEBAGAI  
ALAT BANTU PETHALUTAN PADA PROSES  
PEMANGKATAN

Mahasiswa tersebut telah memenuhi persyaratan dan dapat mengikuti Ujian  
Laporan Akhir/Tugas Akhir (LA/TA) pada Tahun Akademik 2023

Diketahui  
Pembimbing Akademik

(..RIKY BEIJAN Y.M.T.)  
NIP. 19610112020121022

Palembang, 2 Agustus 2023

Pembimbing LA/TA

(..DRS. SOECRANG W.S.T.M.T)  
NIP. 19610104198031003



KEMENTERIAN PENDIDIKAN, KEBUDAYAAN,  
RISET, DAN TEKNOLOGI  
POLITEKNIK NEGERI SRIWIJAYA  
JURUSAN TEKNIK MESIN  
Jalan Srijaya Negara Bukit Besar Palembang 30139  
Telepon. 0711-353414 fax. 0711-355918  
Website : www.polsri.ac.id E-mail : info@polsri.ac.id  
**PELAKSANAAN REVISI LAPORAN AKHIR**

Mahasiswa berikut,

Nama : ALBBY KALMAWAN  
NPM : 062030200792  
Jurusan/Program Studi : TEKNIK MESIN / D3 TEKNIK MESIN  
Judul Laporan Akhir : RANCANG BANGUN GERINDA SUDIPIS SEBAGAI ALAT BANTU PENGHAJATAN  
PADA PROSES PEMBUATAN

Telah melaksanakan revisi terhadap Laporan Akhir yang diujikan pada hari ...SELASA... tanggal ...8...  
bulan ...AGUSTUS... tahun ...2023... Pelaksanaan revisi terhadap Laporan Akhir tersebut telah  
disetujui oleh Dosen Penguji yang memberikan revisi:

No.	Komentar	Nama Dosen Penguji *)	Tanggal	Tanda Tangan
1.	seth direvisi	Indra HB, S.T., M.T.	6/9-23	
2.	seth direvisi	TAUFIKURAHMAN, S.T., M.T.	30/8-2023	
3.	seth direvisi	AHMAD JUNAIDI, S.T., M.T.	28/9-23	
4.	seth direvisi	SIPRONI, S.T., M.T.	6/9-23	
5.	ace	Pt. JOEGENG W., S.T., M.T.	26/9-23	

Palembang, 26 SEPTEMBER 2023

Ketua Penguji \*\*)

( P.T. JOEGENG W., S.T., M.T.)  
NIP. 1961040619880231003

Catatan:

\*) Dosen penguji yang memberikan revisi saat ujian Laporan akhir.  
\*\*) Dosen penguji yang ditugaskan sebagai Ketua Penguji saat ujian LA.  
Lembaran pelaksanaan revisi ini harus dilampirkan dalam Laporan Akhir.





KEMENTERIAN PENDIDIKAN, KEBUDAYAAN,  
RISET, DAN TEKNOLOGI  
POLITEKNIK NEGERI SRIWIJAYA  
JURUSAN TEKNIK MESIN

Jalan Srijaya Negara Bukit Besar - Palembang 30139 Telepon (0711) 353414  
Laman : <http://polsri.ac.id> Pos El : [info@polsri.ac.id](mailto:info@polsri.ac.id)

**BUKTI PENYERAHAN HASIL KARYA/RANCANG BANGUN**

Pada hari ini KAMIS tanggal 24 bulan SEPTEMBER tahun 2023 telah diserahkan seperangkat karya/rancang bangun kepada Jurusan TEKNIK MESIN Program Studi DIJURUSAN TEKNIK MESIN di Politeknik Negeri Sriwijaya,

Nama Perangkat	Spesifikasi
GERINDA SILINDRIS SEBAGAI ALAT BANTU PENGHAUSAN PADA PROSES PEMBUBUTAH	- MOTOR LISTRIK - BATU GERINDA - V-BELT

Hasil karya/rancang bangun dari,

Nama	NPM	Nama Pembimbing
ARIF MAULANA	062030200794	
ALBBY KALYIAWAN	062030200792	Drs. ZAHUDDIN, M.T. Drs. SOEGENG W, S.T., M.T.
M. BAGAS ABITAMA RAHMAN	062030200796	

Yang menerima \*),

(Muhammad SIPAJUDIN, S.T.)  
NIP. 127509112005011004

Palembang, 21 SEPTEMBER 2023  
Yang menyerahkan \*\*),

(ARIF MAULANA.....)  
NPM 062030200794

Mengetahui,  
Ketua Jurusan/KPS,

(Ir. SAIFUL EFFENDI, M.T.)  
NIP. 196309121989031005



\*) pejabat Jurusan/PS yang ditunjuk (Kepala Lab./Bengkel atau Kepala Seksi)  
\*\*) perwakilan mahasiswa dari pembuat karya/rancang bangun.