

Rev:	Date:	Description:	PROJECT NAME	DESIGNED BY	Drawn by:	Checked by:	Project No.:	File Name:
			KLINIK PRAKTIKA J. JENDRAL AHMAD YUSUF KALBE, LILU PALU (PUSKESMAS) SULTAN SELAWAN	DENAH PLAFOND LANTA 2	Skala 1 : 100			

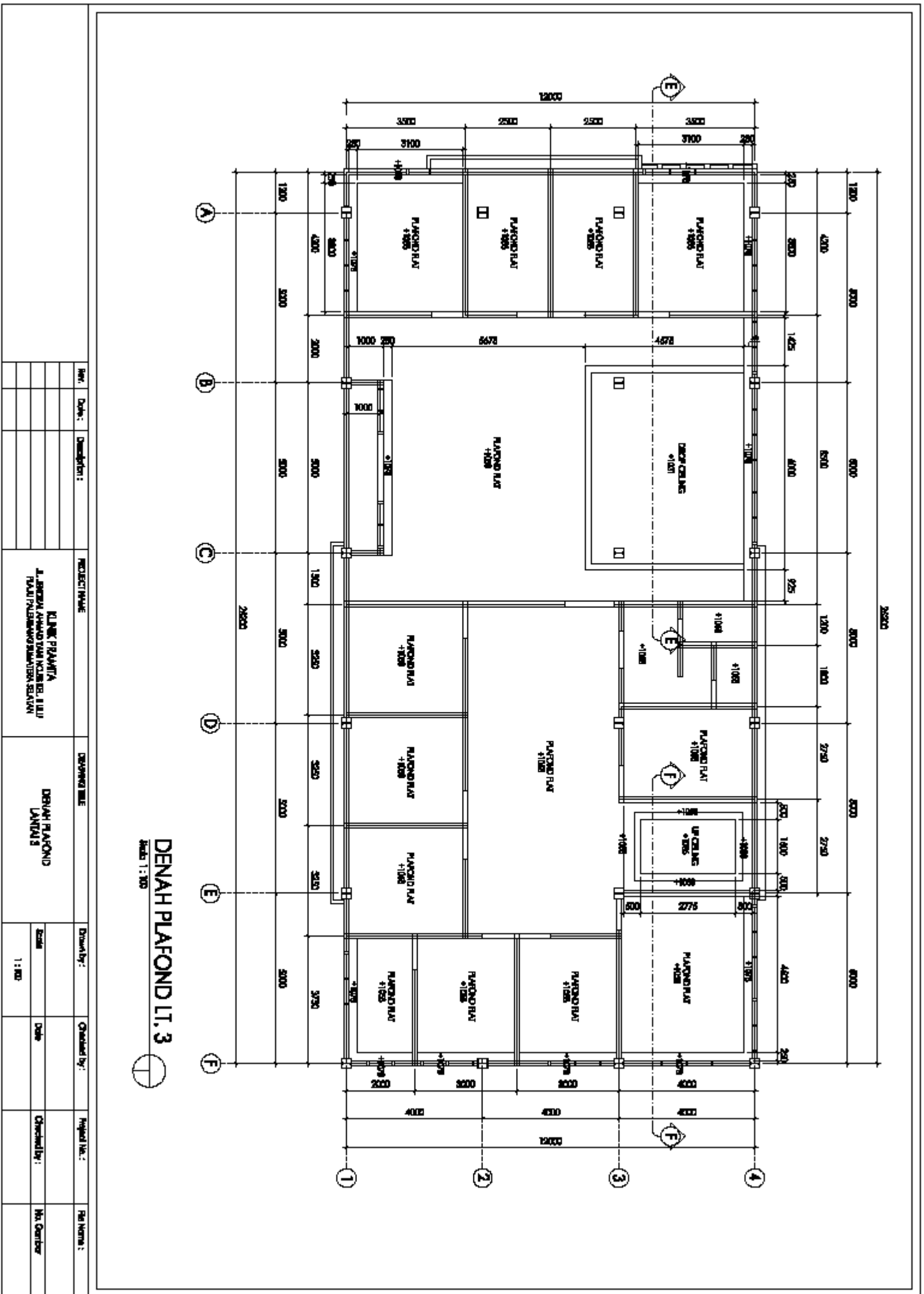

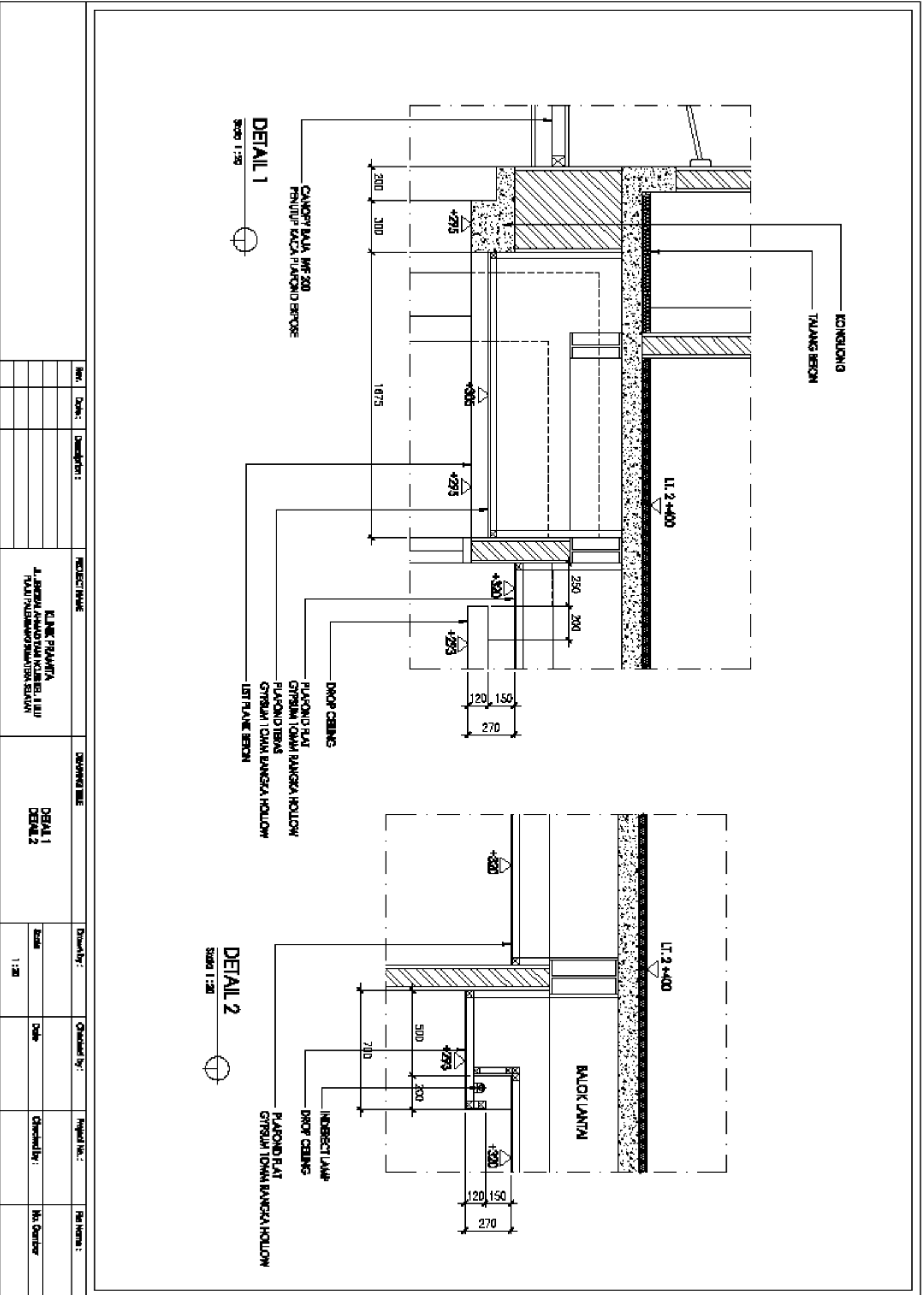



Rev:	Date:	Description:	PROJECT NAME	DETAILED TITLE	Drawn by:	Checked by:	Project No.:	File Name:
			KLINIK PIRAMITA J. JENDAL AHMAD YUS KALBE, 1 LULU PALU (PAREMBANG SURABAYA SELATAN)	DETAIL 1 DETAIL 2				
					Scale	Date	Checked by:	No. Gambar
					1:20			

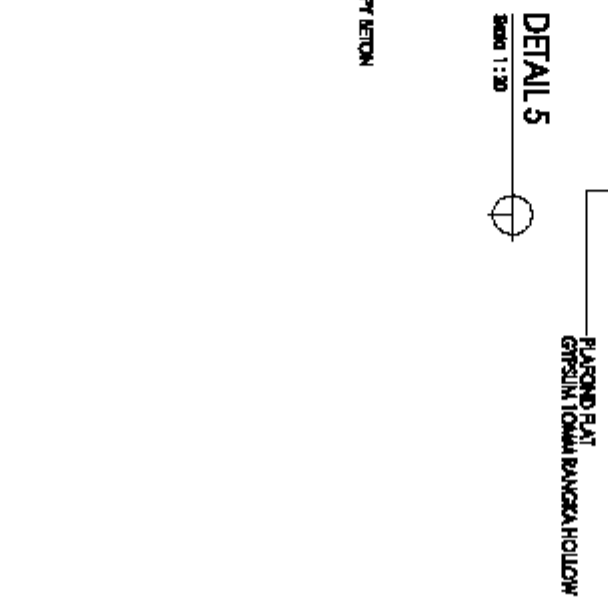
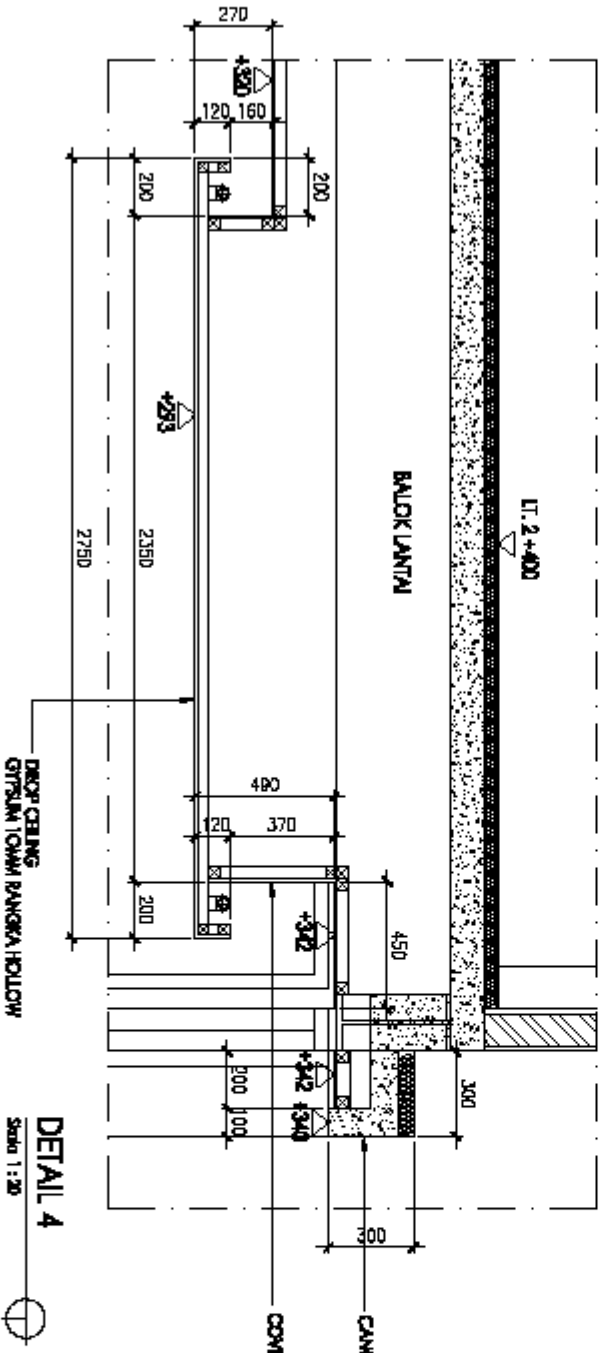
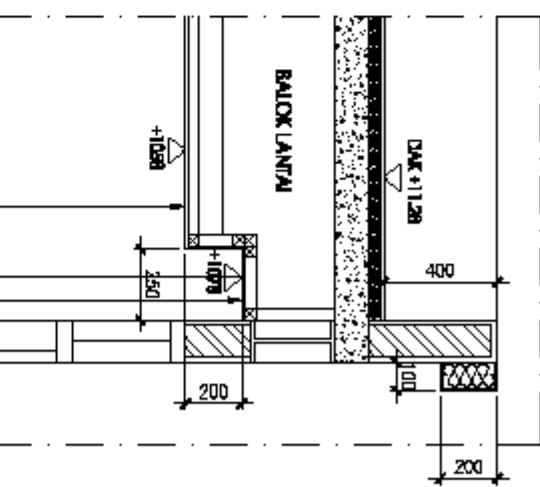
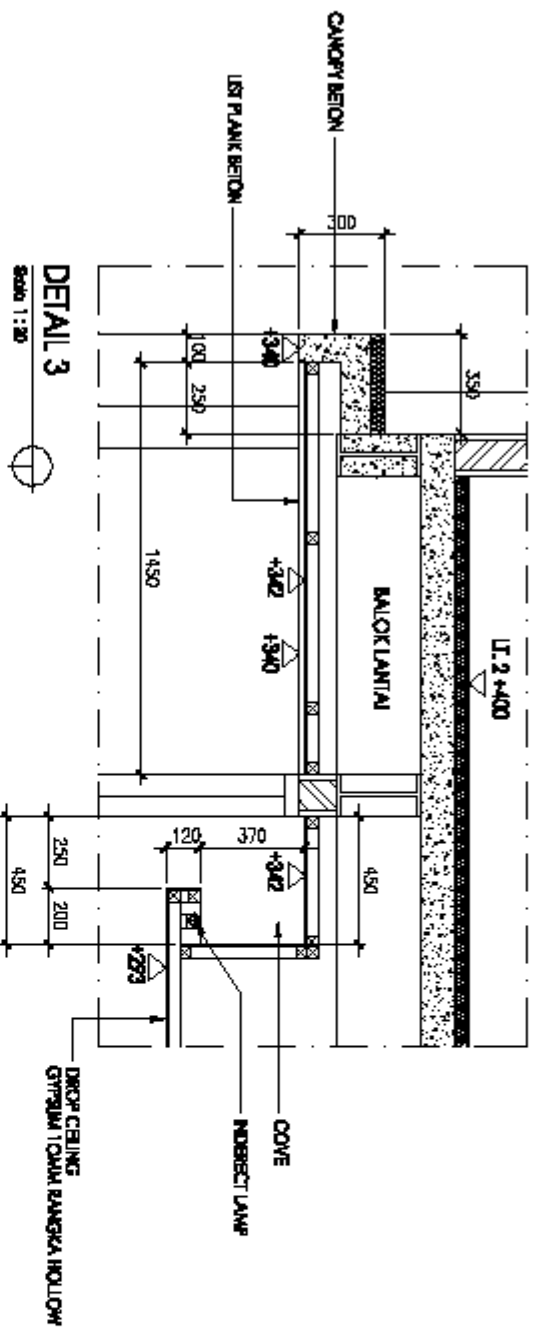

Rev:	Date:	Description:	PROJECT NAME	DESIGNED TITLE	Drawn by:	Checked by:	Project No.:	File Name:
			KLINIK PIRAMITA J. JENDAL AHMAD TUAH KOLBEK, 11111 PULAU PINEBARANG SUMATERA SELATAN	DETAIL 3 DETAIL 4 DETAIL 5				
					Scale	Date	Checked by:	No. Quarter
					1:20			



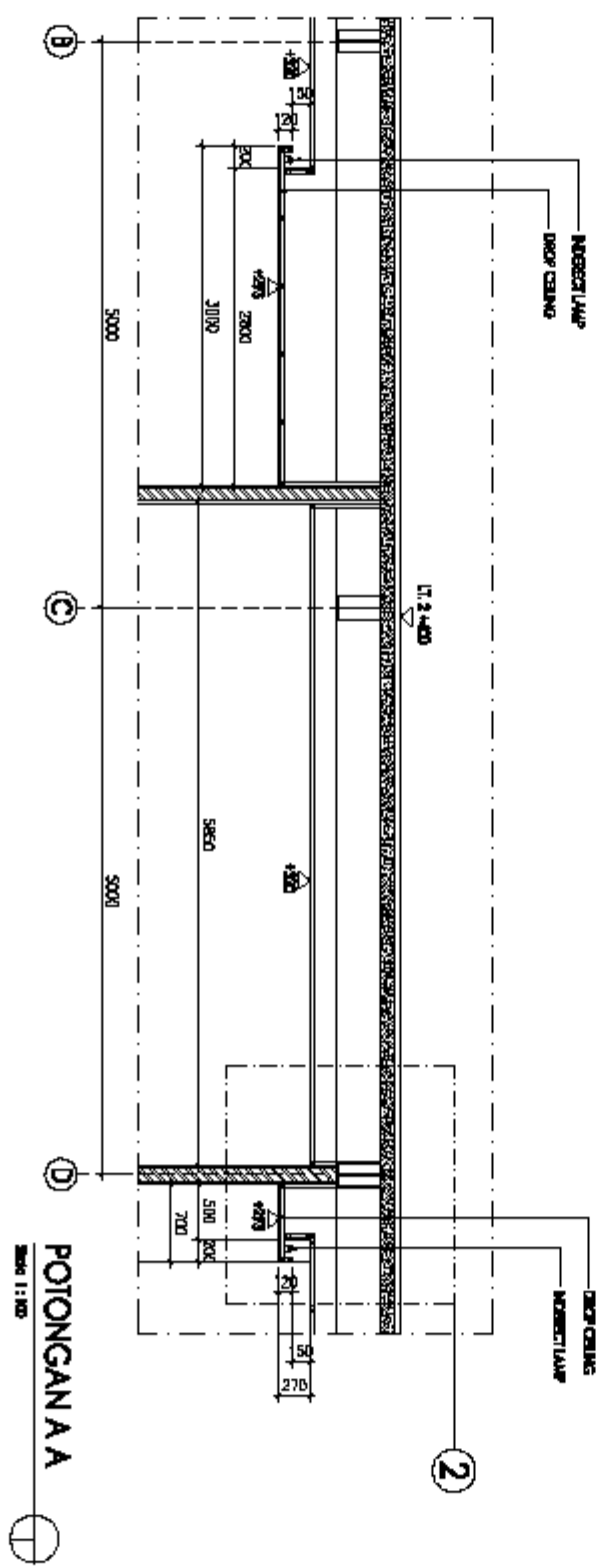
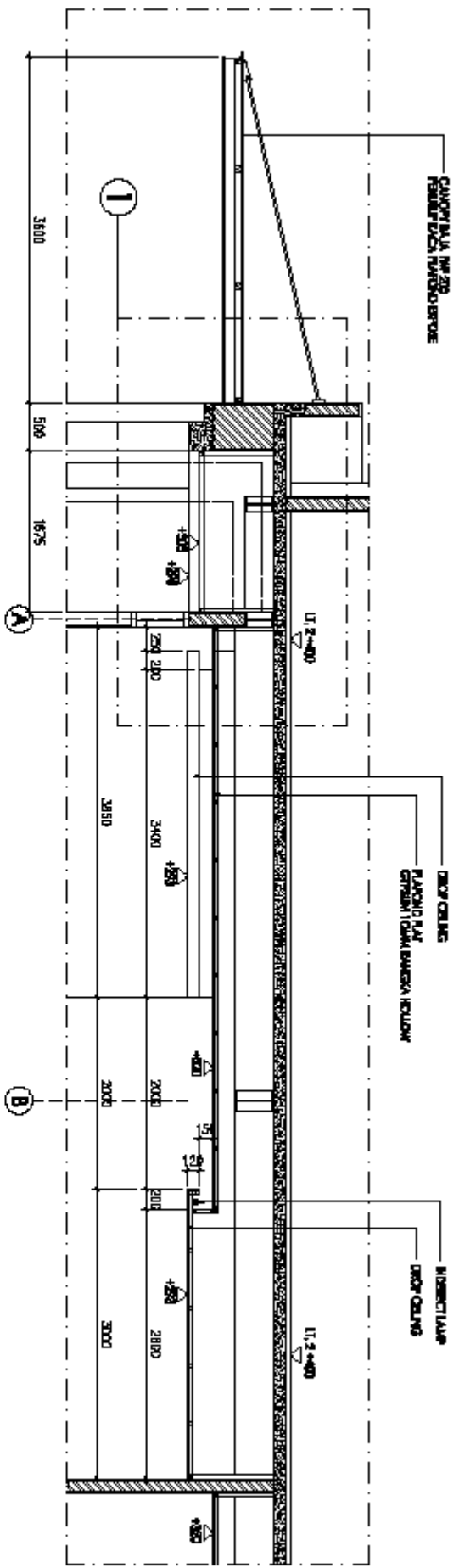

POTONGAN A  
SHEK 1:100

Rev:	Date:	Description:	PROJECT NAME	DESIGNED BY	Drawn by:	Checked by:	Project No.:	File Name:
			KLINIK PIRAMITA J. JENDAL AHMAD YUSUF KOLEK BE. 1 LULU PULAU PEARLHARANG SINGAPORE SIKAWIN	POTONGAN A A	zzam			
					1:100			



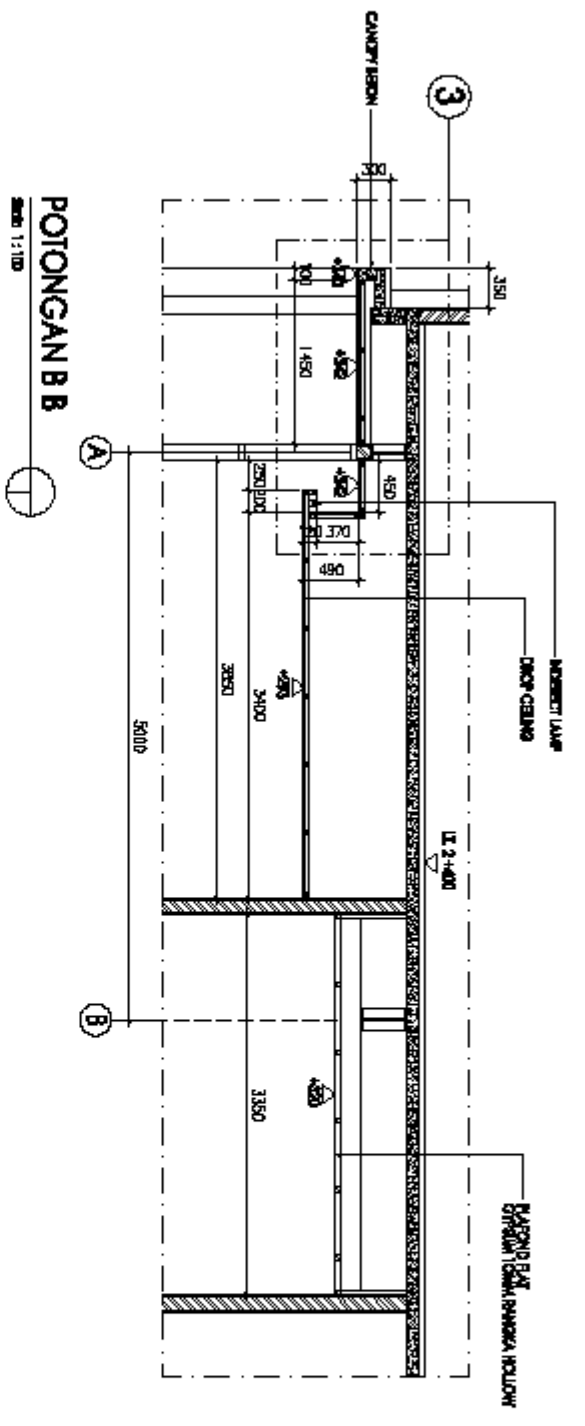

**POTONGAN B B**  
Scale 1:100

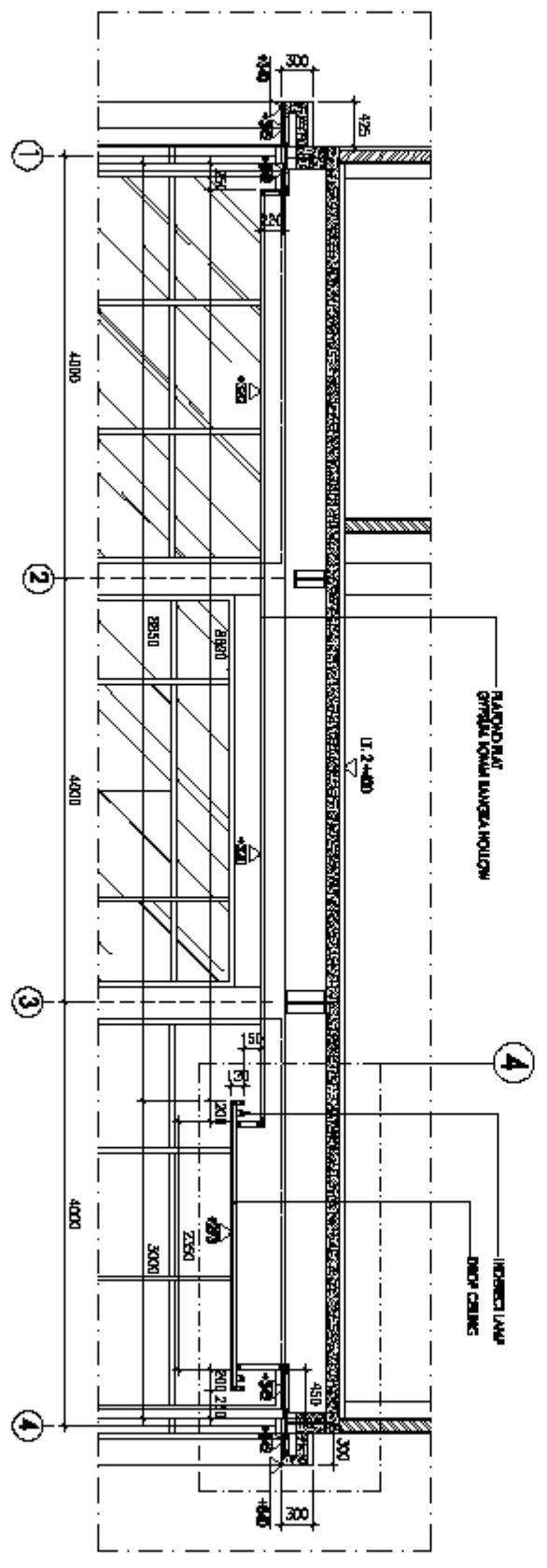

**POTONGAN C C**  
Scale 1:100

Rev:	Date:	Description:	PROJECT NAME	DESIGNED BY	Drawn by:	Checked by:	Project No.:	File Name:
			<b>KLINIK PIRAMITA</b> J. JENDAL AHMAD TAN KOLBEK, 1 LULU PULAU PINEBARANG SUMATERA SELATAN	<b>POTONGAN B B</b> <b>POTONGAN C C</b>	zzam			
					1:100			











□	AMPLI TV
□	TR. AC
□	HAIR CONDITIONER
□	SPRINKLER
□	SMOKER
□	DOWN LIGHT
□	UPPER BALCONY
□	LOWER BALCONY
□	SAJAJAH
□	SARUNG BAYANG
□	TRAYON GUBER
□	DATA CENTER
□	STOP KENDAK
□	MCP

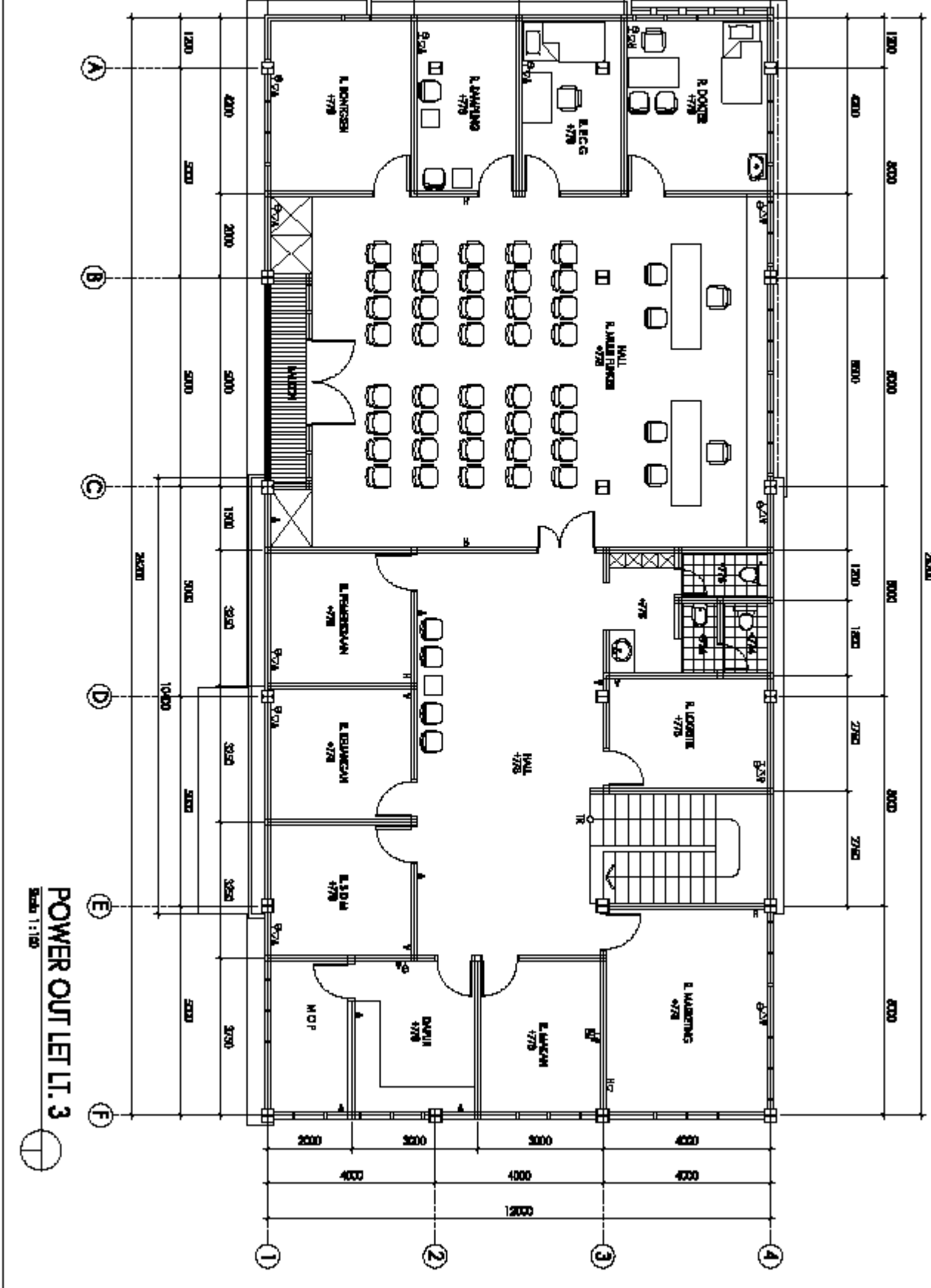

**POWER OUTLET L. 3**  
Scale 1:100

Rev:	Date:	Description:	PROJECT NAME	DEVELOPER TITLE	Drawn by:	Checked by:	Project No.:	File Name:
			KLINIK PIRAMITA TALUK PAREHANG SURABAYA SELATAN	POWER OUTLET LANTAI 3				
					Scale	Date	Checked by:	No. Quarter
					1:100			

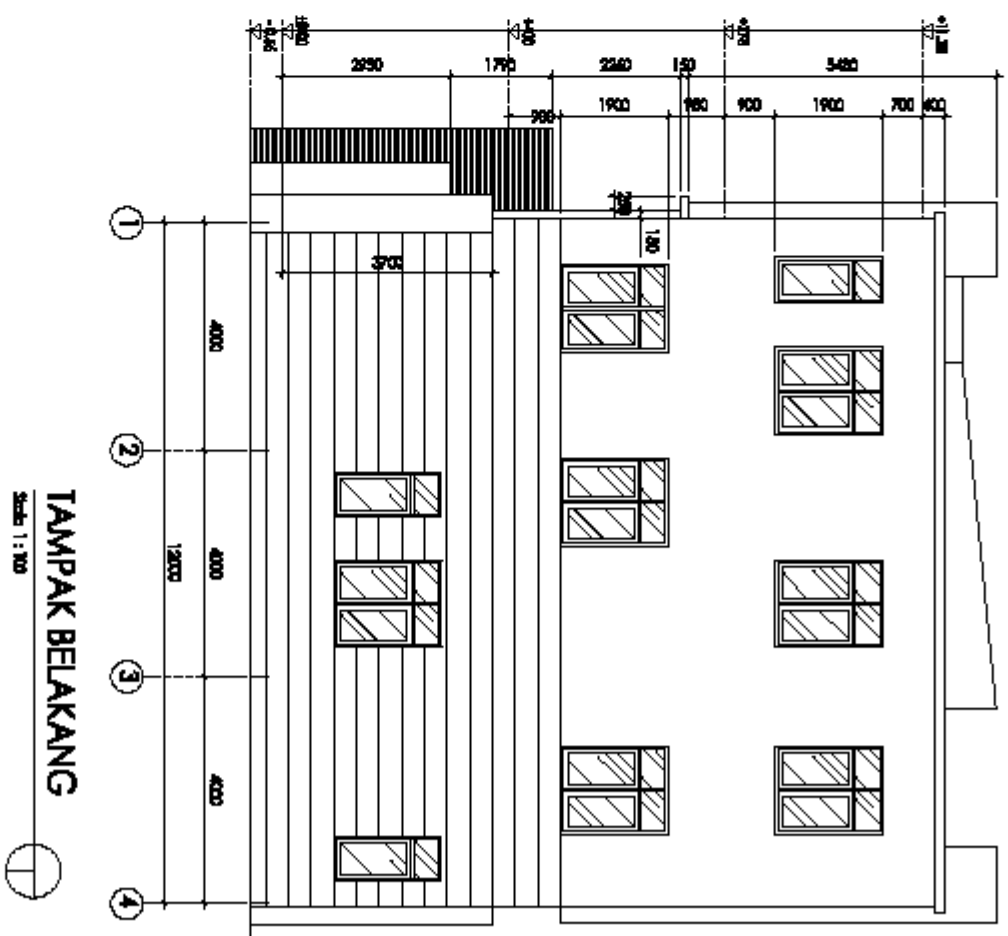
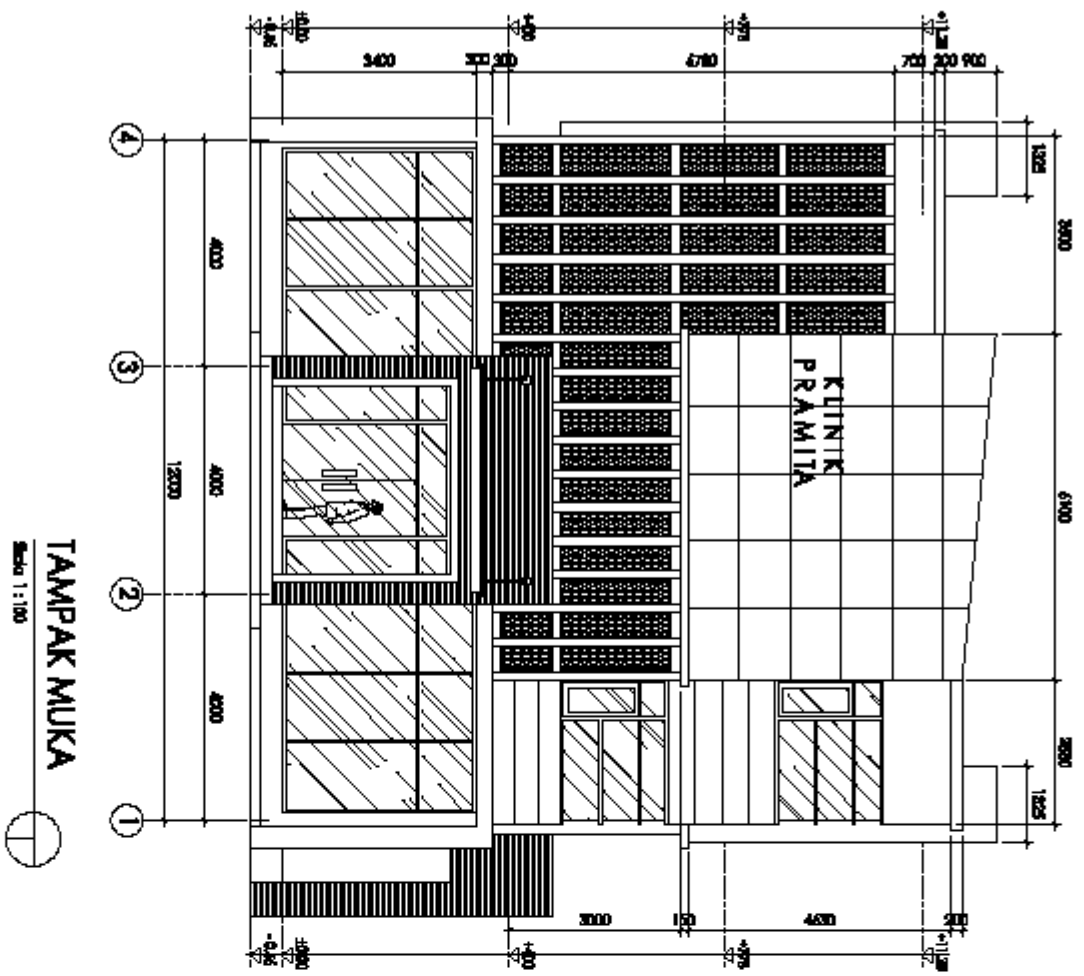

Rev:	Date:	Description:	PROJECT NAME	DEVELOPER TITLE	Drawn by:	Checked by:	Project No.:	File Name:
			KLINIK PRAMITA J. JENDRAL AHMAD YUSUF KALBE, 1 LULU PALU (PUSKESMAS) SUMATERA SELATAN	TAMPAK MUKA TAMPAK BELAKANG	zzam			
					1 : 100			





1	▲	AMPLI TV
2	○	TIK A/C
3	□	HAIR CONDITIONER
4	□	SPRINKLER
5	□	SWITCH MAIN
6	◆	DOWN LIGHT
7	◆	LAMPU BALKON
8	○	LAMPU AMBUNG
9	○	LAMPU BENSANG
10	—	SALJAN
11	◆	SALJAN ALING
12	○	TRONC GILIT
13	□	DANA GILIT
14	○	STOP KONTAK
15	■	KCI

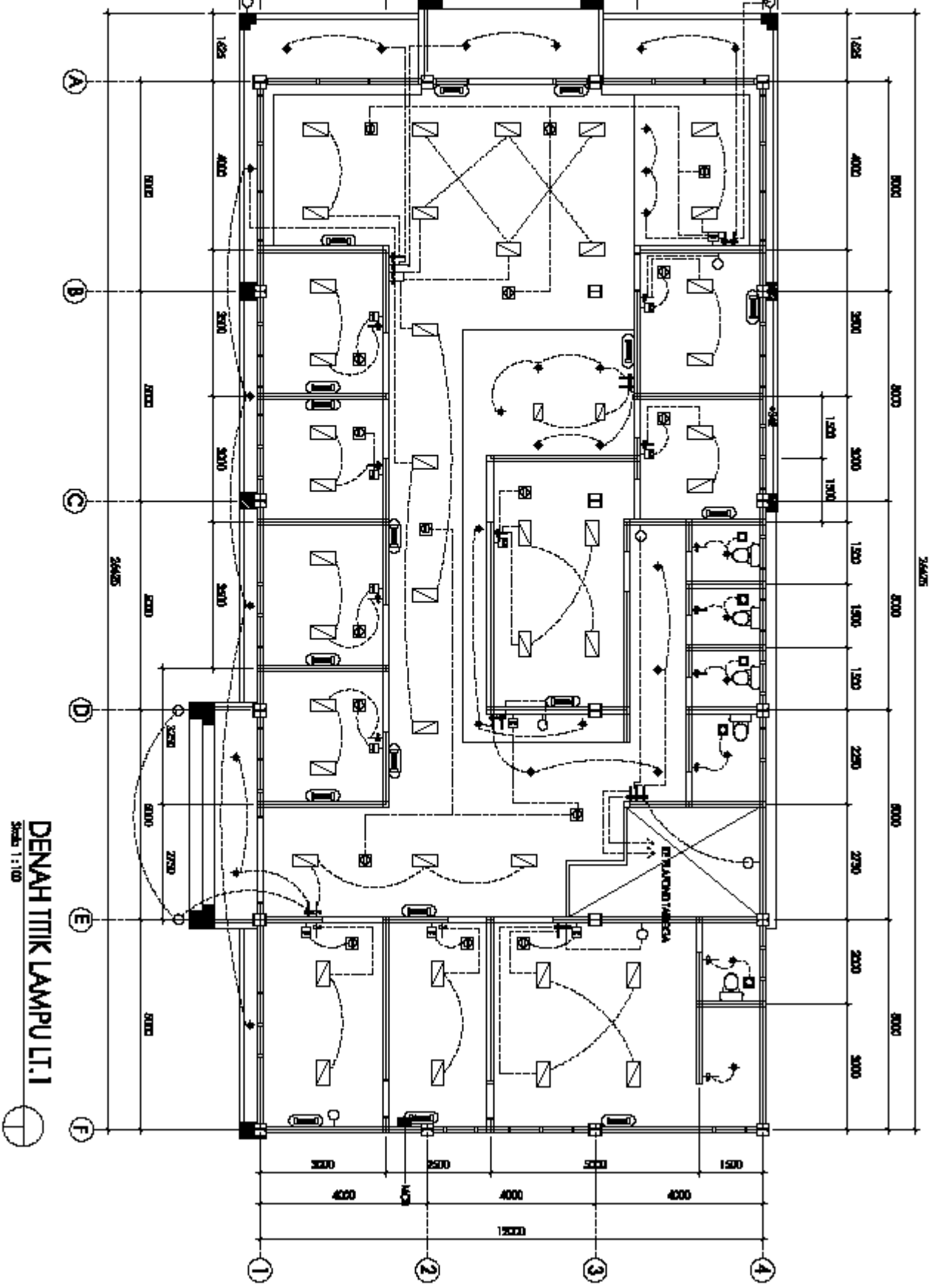

**DENAH TIK LAMPU LT.1**  
 Scale: 1:100

Rev:	Date:	Description:	PROJECT NAME	DEVELOPER TITLE	Drawn by:	Checked by:	Project No.:	File Name:
			<b>KLINIK PIRAMITA</b> J. JENDAL AHMAD TUAH KALBE, 1 LULU PALU (PENERANGAN SUMBERDAYA SEHAT)	<b>TIK LAMPU</b> LAMPU LT.1				
					Scale	Date	Checked by:	No. Drawing
					1 : 100			

□	AMPLATY
○	TRIK A.C
□	HAIR CONDITONER
□	SPRINKLER
□	BEARER PAN
□	DOWN LIGHT
□	LAMPUN BALOKAN
□	LAMPUN AMANTRIS
□	LAMPUN BONGKAS
□	SARJAN
□	SARJAN ALIRAN
□	TRAYON GILBER
□	DANA GILBER
□	STOP KONTAK
□	KCI

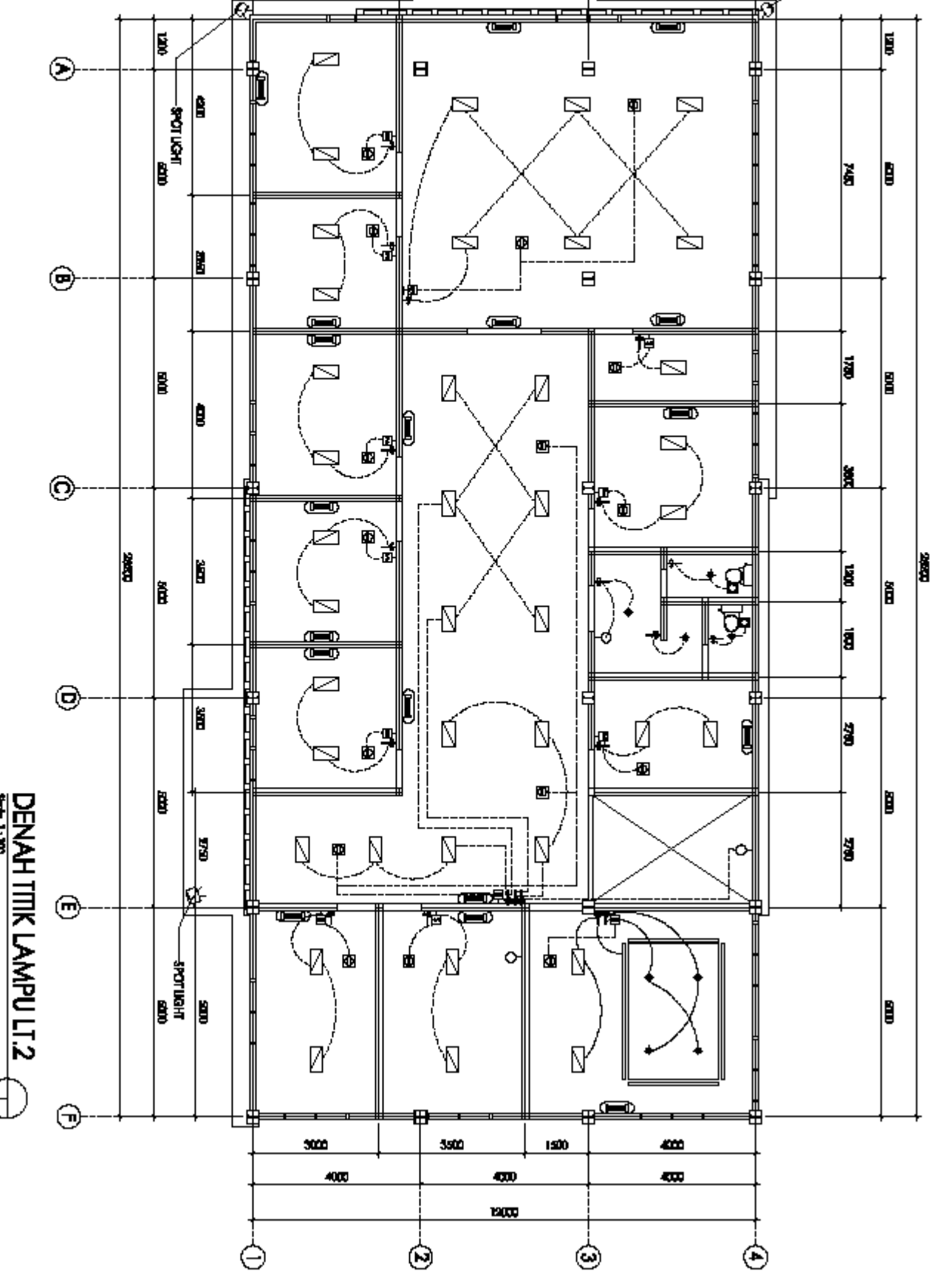

**DENAH TITIK LAMPU LT.2**  
Scale 1:100

Rev:	Date:	Description:	PROJECT NAME	DESIGNED BY	Drawn by:	Checked by:	Project No.:	File Name:
			KLINIK PIRAMITA J. JENDAL AHMAD TUAH KALBE, 1 LULU PALU (PERSERIKATAN SULTANEN SELAWAN)	TITIK LAMPU LAMPUN 2	1:100			