

CATATAN

REVISI

NO	TGL	KET.	PARAF

POLITEKNIK NEGERI SRIWIJAYA
PALEMBANG
2016



JURUSAN TEKNIK SIPIL
KONSENTRASI GEDUNG

JUDUL LAPORAN AKHIR

PERENCANAAN GEDUNG KULIAH
FAKULTAS ILMU SOSIAL DAN ILMU
POLITIK (FISIP) UNIVERSITAS SRIWIJAYA
KOTA PALEMBANG

PERENCANA

ACHMAD TRANDZ
NIM. 09152010028

AZAL PERMANAWAN
NIM. 09152010030

DIPERIKSA

DOSEN PEMBIMBING I

Dr. Rida Murningsih, S.T., M.T.,
NIP. 19570901198001001

DOSEN PEMBIMBING II

Sumardi, S.T., M.T.,
NIP. 19540501198001002

JUDUL GAMBAR

DENAH LANTAI 3

KODE ARS-03

SKALA NO. GBR. JIL. GBR.

1 : 50

03

13

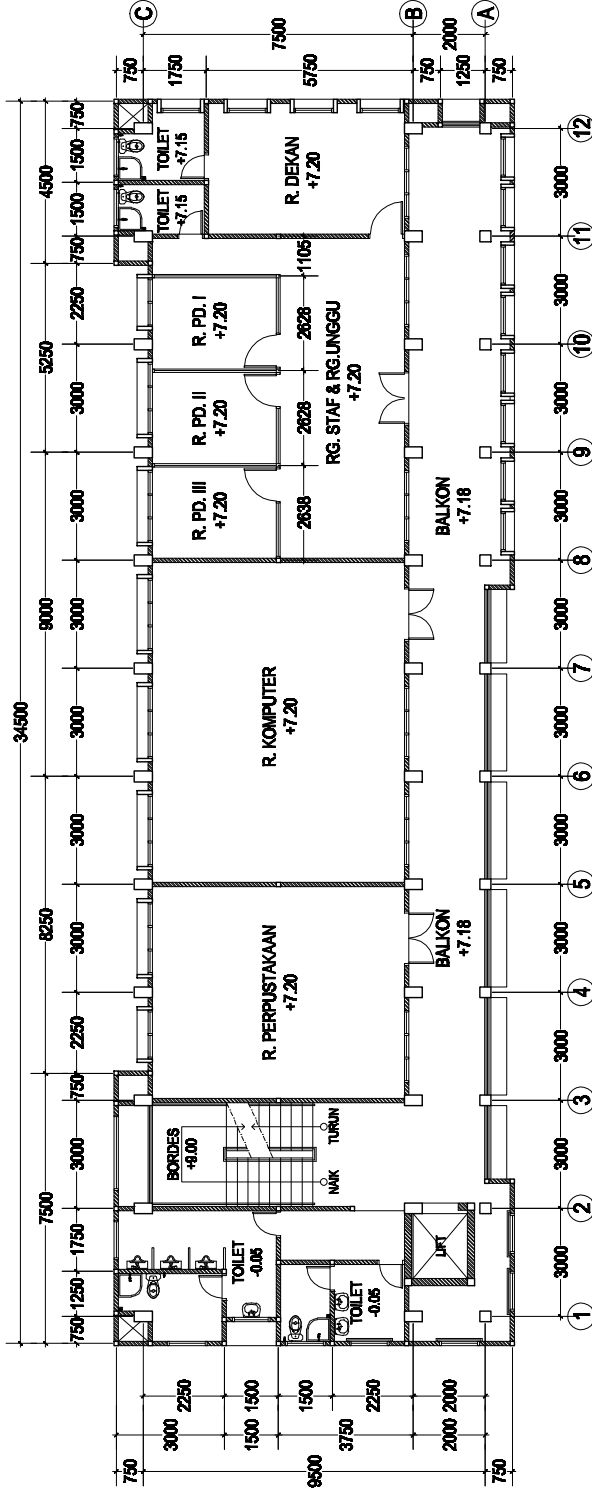

DENAH LANTAI 3
Skala 1:50

CATATAN

REVISI

NO	TGL	KET.	PARAF

POLITEKNIK NEGERI SRIWIJAYA
PALEMBANG
2016



JURUSAN TEKNIK SIPIL
KONSENTRASI GEDUNG

JUDUL LAPORAN AKHIR

PERENCANAAN GEDUNG KULIAH
FAKULTAS ILMU SOSIAL DAN ILMU
POLITIK (FISIP) UNIVERSITAS SRIWIJAYA
KOTA PALEMBANG

PERENCANA

ACHMAD TRANDZ
NIM. 091520100008

AZAL PERMANAWAN
NIM. 091520100009

DIPERIKSA

DOSEN PEMBIMBING I

Dr. Rida Murningsih, S.T., M.T.,
NIP. 19570901198001001

DOSEN PEMBIMBING II

Sumardi, S.T., M.T.,
NIP. 19510401198001002

JUDUL GAMBAR

DENAH LANTAI 4

KODE ARS-04

SKALA 1 : 50

NO. GBR. JILH. GBR

04

13

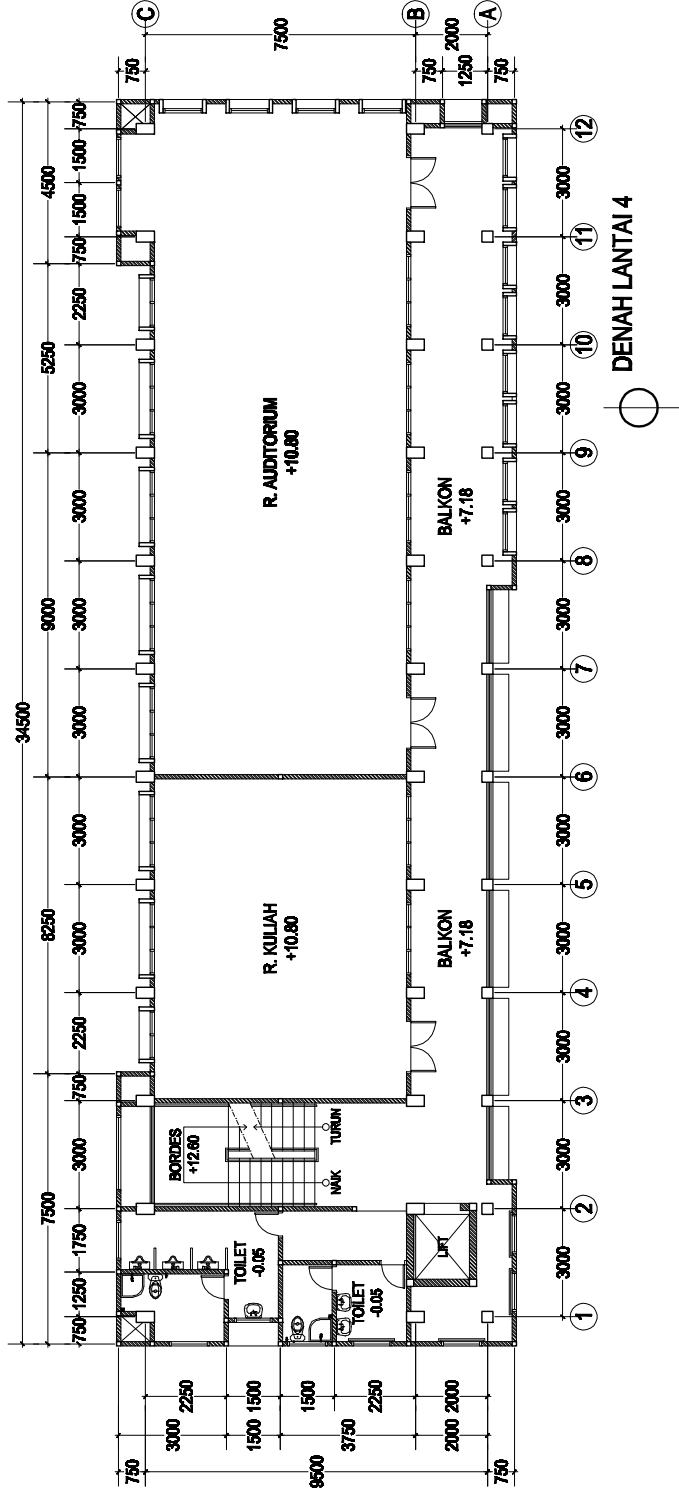

CATATAN

REVISI

NO	TGL.	KET.	PARAF

POLITEKNIK NEGERI SRIWIJAYA
PALEMBANG
2016



JURUSAN TEKNIK SIPIL
KONSENTRASI GEDUNG

JUDUL LAPORAN AKHIR

PERENCANAAN GEDUNG KULIAH
FAKULTAS ILMU SOSIAL DAN ILMU
POLITIK (FISIP) UNIVERSITAS SRIWIJAYA
KOTA PALEMBANG

PERENCANA

ACHMAD TRANDZ
NIM. 09152010028

AZAL PERMANAWAN
NIM. 09152010028

DIPERIKSA

DOSEN PEMBIMBING I

PARAF

Dr. Rida Murningsih, S.T., M.T.,
NIP. 19670901198001001

DOSEN PEMBIMBING II

PARAF

Sumardi, S.T., M.T.,
NIP. 19610401198001002

JUDUL GAMBAR

DENAH LANTAI 5

KODE ARS-05

SKALA 1 : 50

NO. GBR. JIL. GBR.

05

13

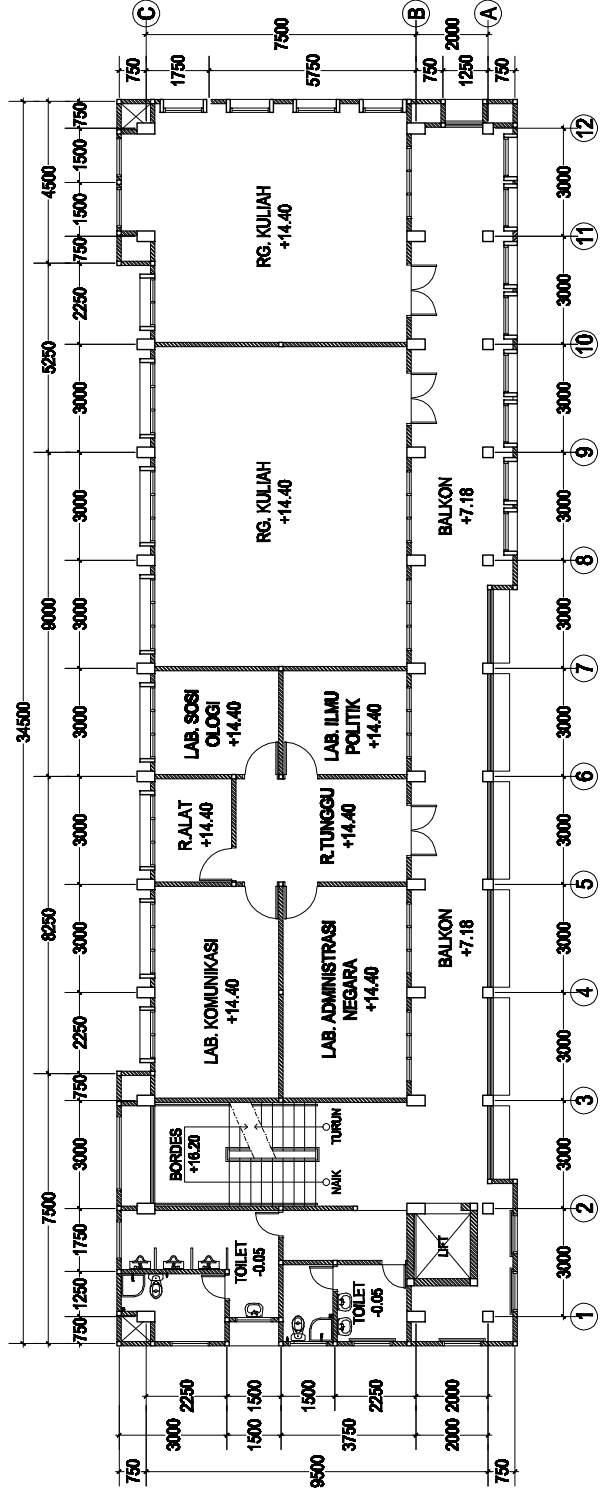

DENAH LANTAI 5

Scale 1:50

CATATAN

REVISI

NO	TGL	KET.	PARAF

POLITEKNIK NEGERI SRIWIJAYA
PALEMBANG
2016



JURUSAN TEKNIK SIPIL
KONSENTRASI GEDUNG

JUDUL LAPORAN AKHIR

PERENCANAAN GEDUNG KULIAH
FAKULTAS ILMU SOSIAL DAN ILMU
POLITIK (FISIP) UNIVERSITAS SRIWIJAYA
KOTA PALERANG

PERENCANA

ACHMAD TRANDY
NIM. 09150100208

AZAL PERAWAN
NIM. 09150100208

DIPERIKSA

DOSEN PEMBIMBING I

Dr. Rida Murningsih, S.T., M.T.,
NIP. 19570001198001001

DOSEN PEMBIMBING II

Sumardi, S.T., M.T.,
NIP. 1951010198001002

JUDUL GAMBAR

DENAH LANTAI ATAP DAG

KODE

ARS-06

SKALA

1 : 50

NO. GBR

06

JLH. GBR

13

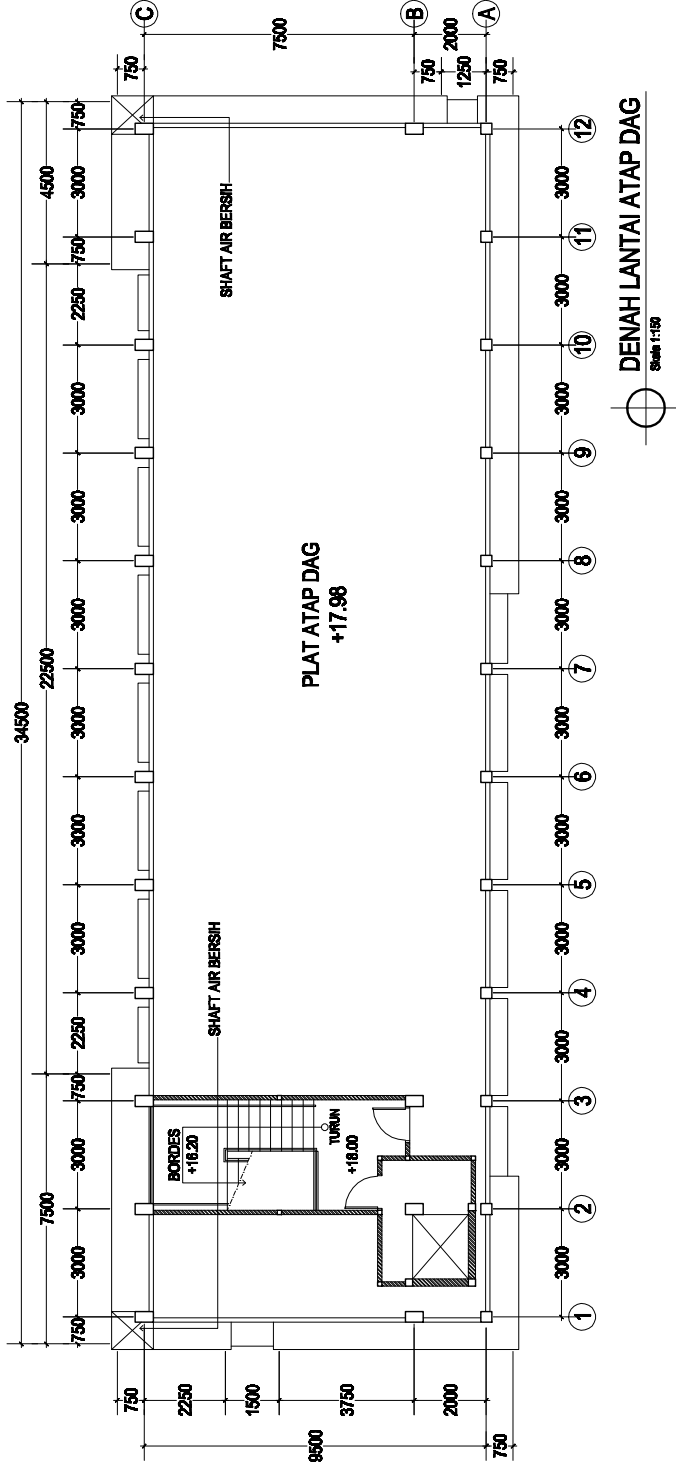

CATATAN		
REVISI		
NO	TGL	KEF. PARAF
POLITEKNIK NEGERI SRIWIJAYA PALEMBANG 2016		
 JURUSAN TEKNIK SIPIL KONSENTRASI GEDUNG		
JUDUL LAPORAN AKHIR PERENCANAAN GEDUNG KULIAH FAKULTAS ILMU SOSIAL DAN ILMU POLITIK (FISIP) UNIVERSITAS SRIWIJAYA KOTA PALERANG		
PERENCANA		
ACHMAD TRANDZ NIM. 07152010028	AZAL PERAWAN NIM. 06152010050	
DIPERIKSA		
DOSEN PEMBIMBING I	PARAF	
Dr. Rida Murningsih, S.T., M.T., NIP. 19570001198001001		
DOSEN PEMBIMBING II	PARAF	
Sumardi, S.T., M.T., NIP. 1951010198001002		
JUDUL GAMBAR		
DENAH ATAP DAG TANGGA		
KODE	SKALA	NO. GBR
ARS-07	1 : 50	07
		13

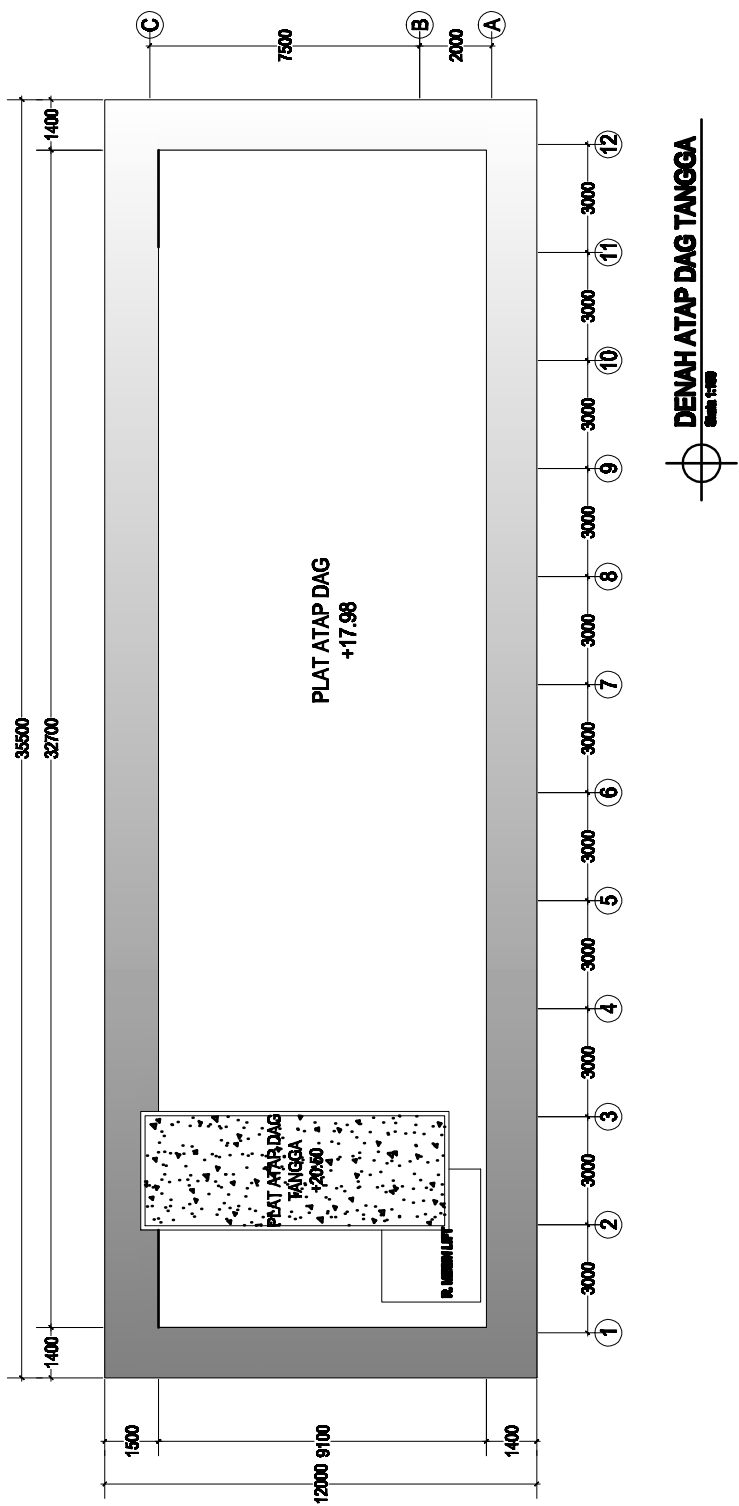

CATATAN

REVISI

NO	TGL.	KET.	PARAF

POLITEKNIK NEGERI SRIWIJAYA
PALEMBANG
2016



JURUSAN TEKNIK SIPIL
KONSENTRASI GEDUNG

JUDUL LAPORAN AKHIR

PERENCANAAN GEDUNG KULIAH
FAKULTAS ILMU SOSIAL DAN ILMU
POLITIK (FISIP) UNIVERSITAS SRIWIJAYA
KOTA PALERANG

PERENCANA

ACHMAD TRANDI Z
NIM. 0015201400008

AZMI BERAWAN
NIM. 0015201400009

DIPERIKSA

DOSEN PEMBIMBING I

PARAF

Dr. Rida Murningsih, S.T., M.T.,
NIP. 19570001198001001

DOSEN PEMBIMBING II

PARAF

Sumardi, S.T., M.T.,
NIP. 19510401198001002

JUDUL GAMBAR

TAMPAK DEPAN

KODE	SKALA	NO. GBR	JLH. GBR
ARS-08	1 : 50	08	13

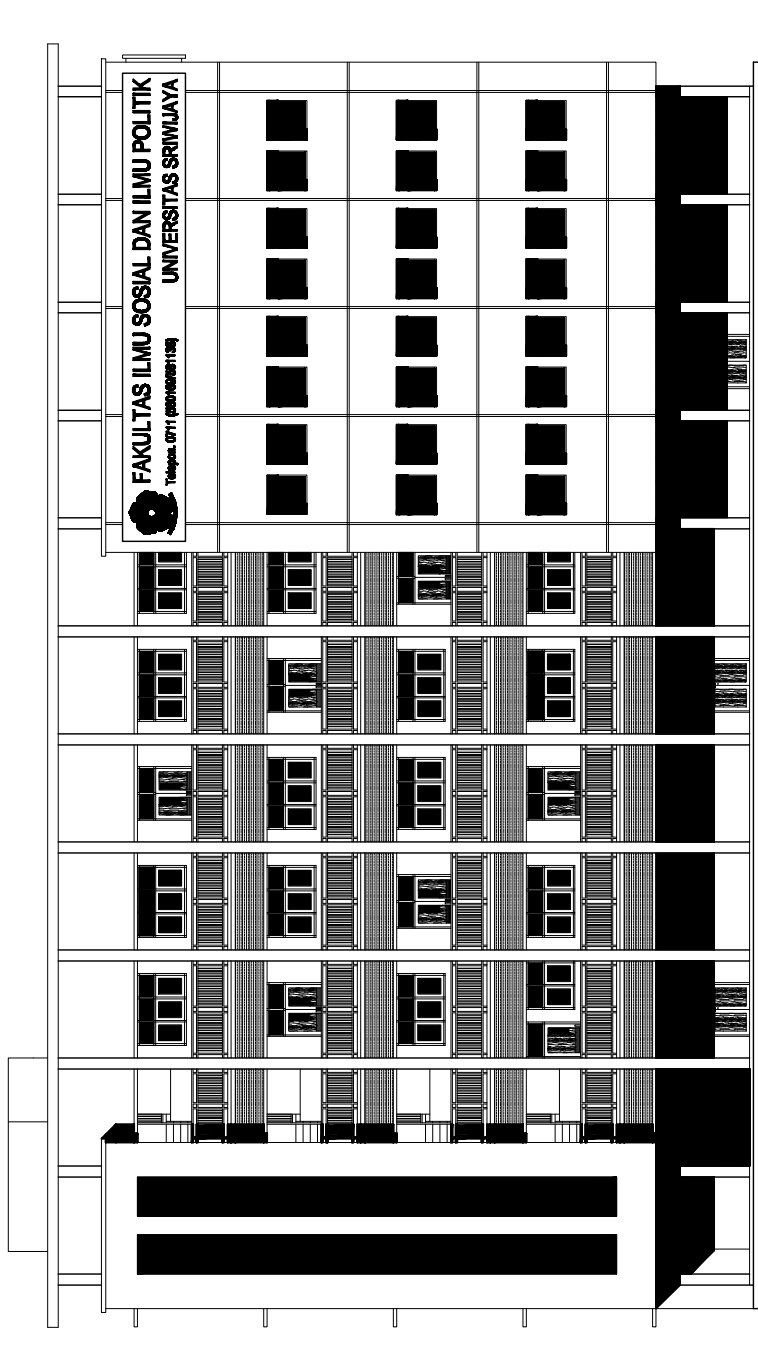

TAMPAK DEPAN

Scale 1:50

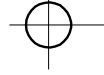

CATATAN

REVISI

NO	TGL.	KET.	PARAF

POLITEKNIK NEGERI SRIWIJAYA
PALEMBANG
2016



JURUSAN TEKNIK SIPIL
KONSENTRASI GEDUNG

JUDUL LAPORAN AKHIR

PERENCANAAN GEDUNG KULIAH
FAKULTAS ILMU SOSIAL DAN ILMU
POLITIK (FISIP) UNIVERSITAS SRIWIJAYA
KOTA PALEMBANG

PERENCANA

ACHMAD TRANDI Z
NIM. 0915010028

AZAL HERNAWAN
NIM. 0915010030

DIPERIKSA

DOSEN PEMBIMBING I

PARAF

Dr. Rida Murningsih, S.T., M.T.,
NIP. 19570001198001001

DOSEN PEMBIMBING II

PARAF

Sumardi, S.T., M.T.,
NIP. 1954010198001002

JUDUL GAMBAR

TAMPAK SAMPIING KANAN

KODE | SKALA | NO. GBR | JEL. GBR

ARS-09

1 : 50

09

13

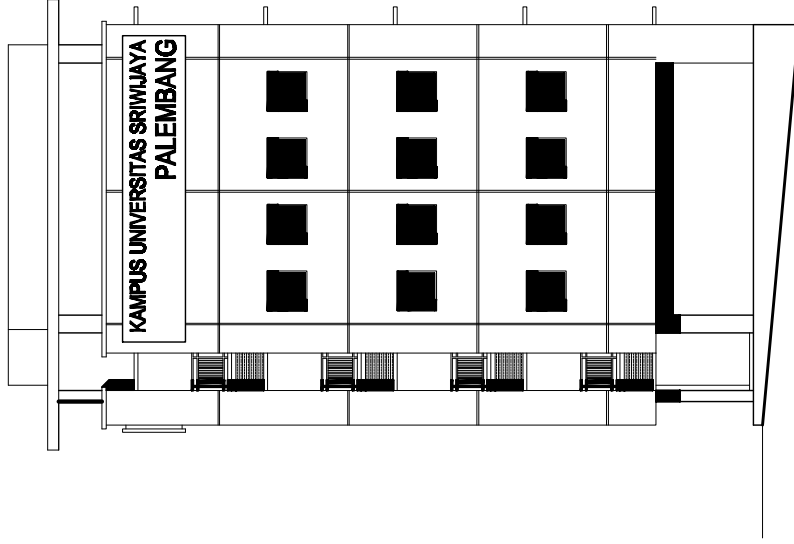

TAMPAK SAMPIING KANAN

Scale 1:50

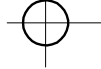

CATATAN

REVISI

NO	TGL.	KET.	PARAF

POLITEKNIK NEGERI SRIWIJAYA
PALEMBANG
2016



JURUSAN TEKNIK SIPIL
KONSENTRASI GEDUNG

JUDUL LAPORAN AKHIR

PERENCANAAN GEDUNG KULIAH
FAKULTAS ILMU SOSIAL DAN ILMU
POLITEK (FISIP) UNIVERSITAS SRIWIJAYA
KOTA PALLEMBANG

PERENCANA

ACHMAD TRANDI Z
NIM. 001500100008

AZAL BERAWAN
NIM. 001500100009

DIPERIKSA

DOSEN PEMBIMBING I

PARAF

Dr. Rida Murningsih, S.T., M.T.,
NIP. 19570001198001001

DOSEN PEMBIMBING II

PARAF

Sumardi, S.T., M.T.,
NIP. 19510010198001002

JUDUL GAMBAR

TAMPAK SAMPIING KIRI

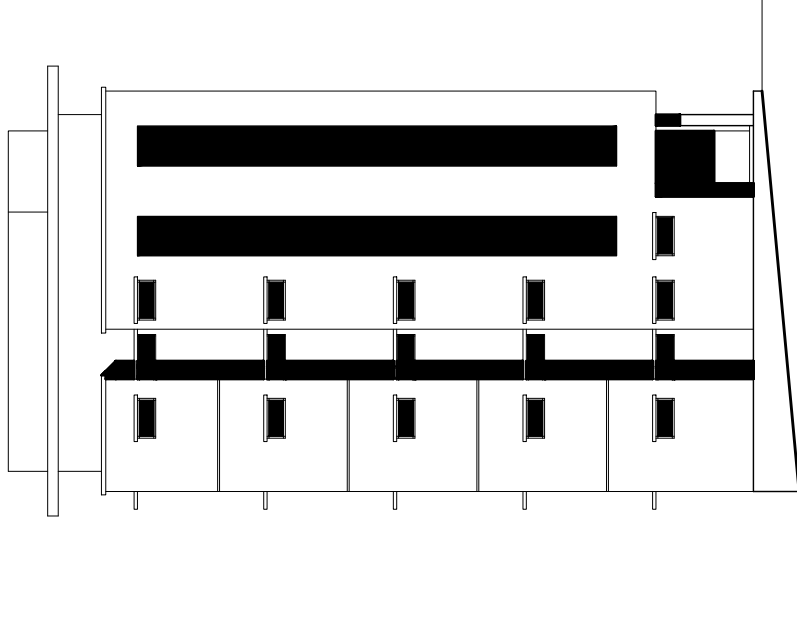

TAMPAK SAMPIING KIRI

Skala 1:100

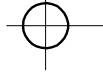

KODE | SKALA | NO. GBR | JEL. GBR

ARS-10 | 1 : 50 | 10 | 13

CATATAN

REVISI

NO	TGL.	KRT.	PARAF

POLITEKNIK NEGERI SRIWIJAYA
PALEMBANG
2016



JURUSAN TEKNIK SIPIL
KONSENTRASI GEDUNG

JUDUL LAPORAN AKHIR

PERENCANAAN GEDUNG KULIAH
FAKULTAS ILMU SOSIAL DAN ILMU
POLITIK (FISIP) UNIVERSITAS SRIWIJAYA
KOTA PALEMBANG

PERENCANA

ACHMAD TRANDY
NIM. 001520100008

AZAL PERMANAWAN
NIM. 001520100009

DIPERIKSA

DOSEN PEMBIMBING I

Dr. Rida Mumpuni, S.T., M.T.,
NIP. 1957000198001001

DOSEN PEMBIMBING II

Sumardi, S.T., M.T.,
NIP. 1954010198001002

JUDUL GAMBAR

TAMPAK BELAKANG

KODE	SKALA	NO. GBR	JLH. GBR
ARS-11	1 : 50	11	13

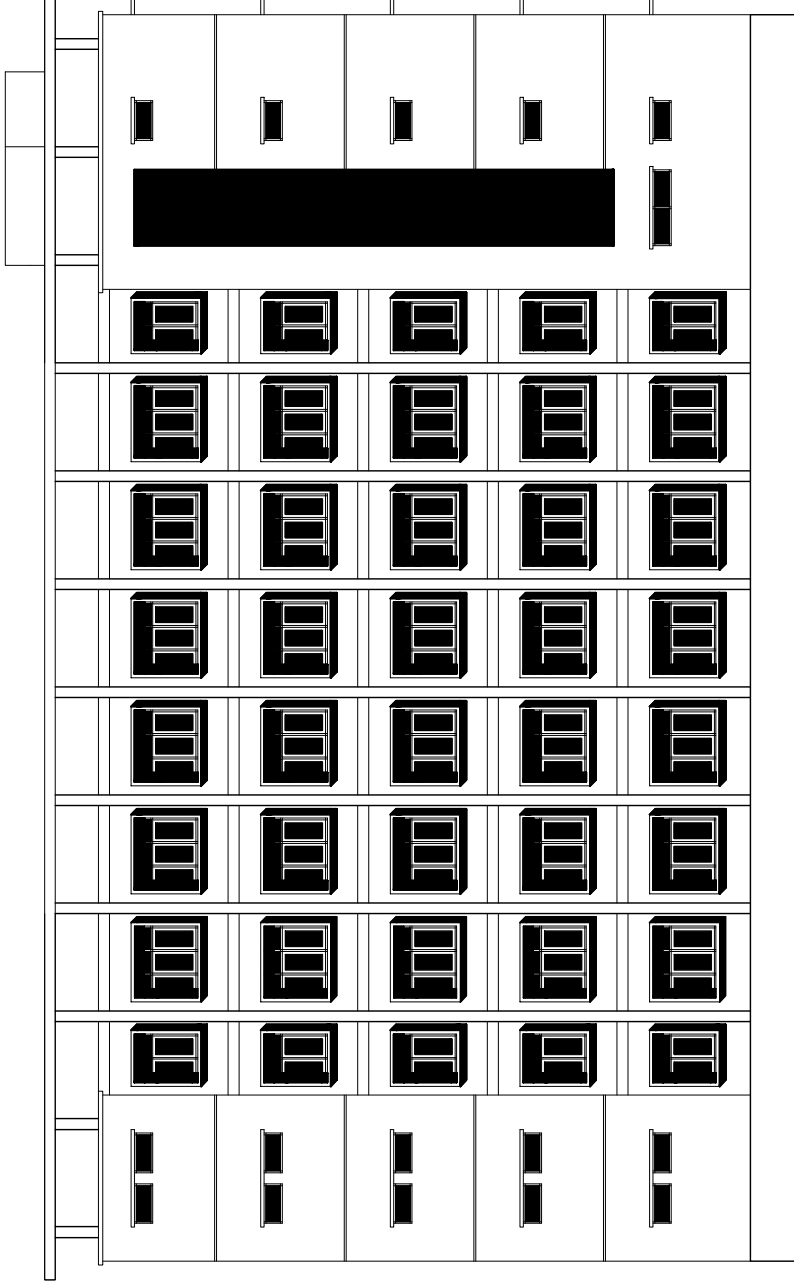

TAMPAK BELAKANG

Skala 1:50

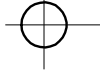

CATATAN

REVISI

NO	TGL.	KET.	PARAF

POLITEKNIK NEGERI SRIWIJAYA
PALEMBANG
2016



JURUSAN TEKNIK SIPIL
KONSENTRASI GEDUNG

JUDUL LAPORAN AKHIR

PERENCANAAN GEDUNG KULIAH
FAKULTAS ILMU SOSIAL DAN ILMU
POLITIK (FISIP) UNIVERSITAS SRIWIJAYA
KOTA PALEMBANG

PERENCANA

ACHMAD TRANDZ
NIM. 09152010028

AZAL BERAWAN
NIM. 09152010030

DIPERIKSA

DOSEN PEMBIMBING I

Dr. Rida Murningsih, S.T., M.T.,
NIP. 19570501198001001

DOSEN PEMBIMBING II

Sumardi, S.T., M.T.,
NIP. 19540501198001002

JUDUL GAMBAR

POTONGAN 01-01

KODE ARS-12

SKALA 1 : 50

NO. GBR. 12

JLH. GBR. 13

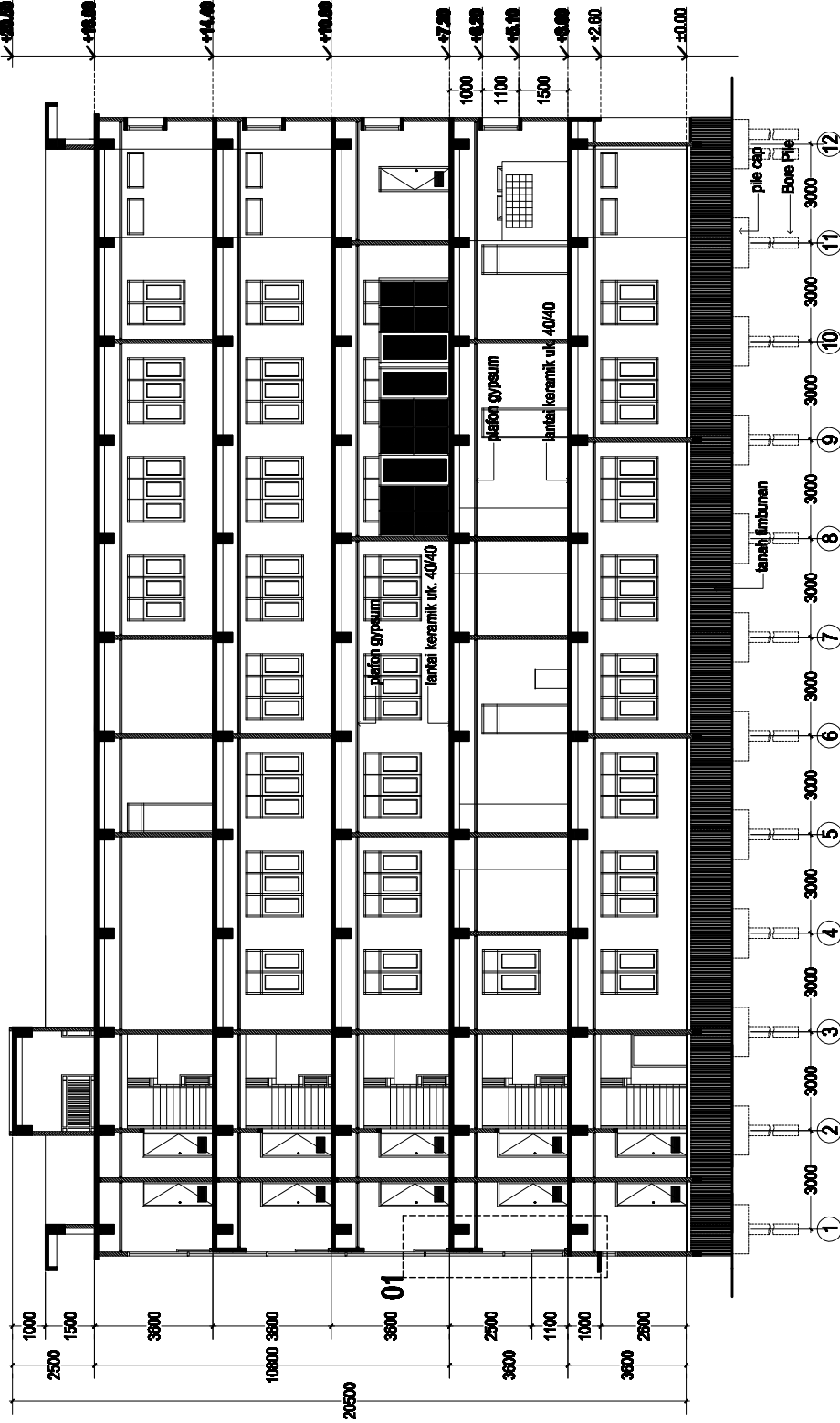

POTONGAN 01-01

Skala 1:50

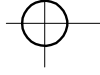

CATATAN

REVISI

NO	TGL	KET.	PARAF

POLITEKNIK NEGERI SRIWIJAYA
PALEMBANG
2016



JURUSAN TEKNIK SIPIL
KONSENTRASI GEDUNG

JUDUL LAPORAN AKHIR

PERENCANAAN GEDUNG KULIAH
FAKULTAS ILMU SOSIAL DAN ILMU
POLITIK (FISIP) UNIVERSITAS SRIWIJAYA
KOTA PALLEMBANG

PERENCANA

ACEMAD TRANDZ
NIM. 09150100208

DIPERIKSA

DOSEN PEMBIMBING I
Drs. Rudi Mumpuni, S.T., M.T.,
NIP. 19570001199001001

DOSEN PEMBIMBING II
Samsul Bahri, S.T., M.T.,
NIP. 19510101199001002

JUDUL GAMBAR

POTONGAN 02-02

KODE	SKALA	NO. GBR	JLH. GBR
ARS-13	1 : 50	13	13

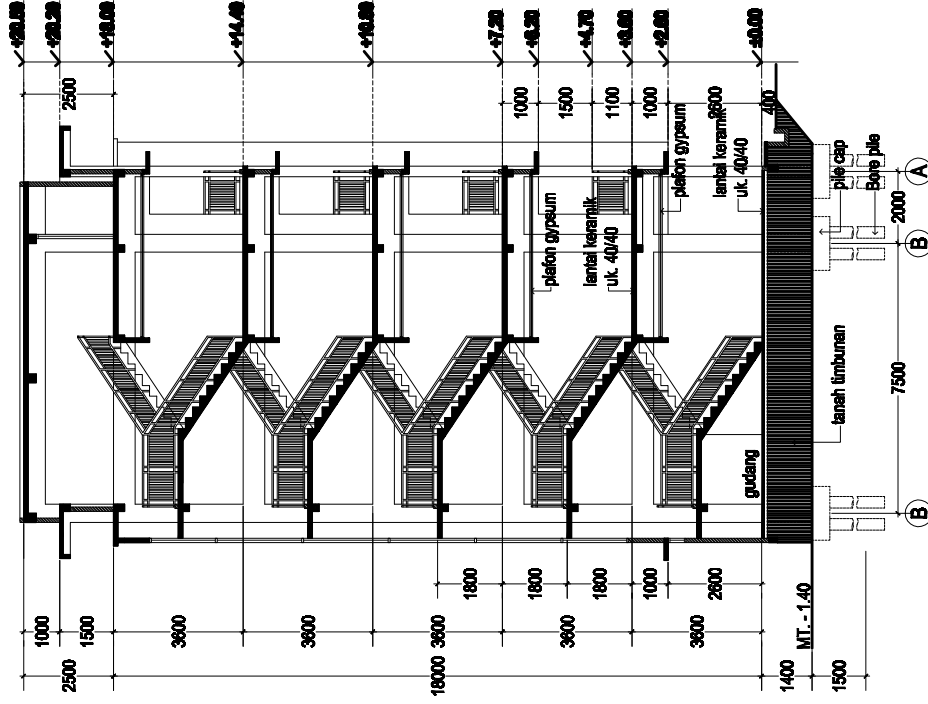

POTONGAN 02-02

Scale 1:50

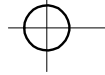

CATATAN

REVISI

NO	TGL	KRT.	PARAF

POLITEKNIK NEGERI SRIWIJAYA
PALEMBANG
2016



JURUSAN TEKNIK SIPIL
KONSENTRASI GEDUNG

JUDUL LAPORAN AKHIR

PERENCANAAN GEDUNG KULIAH
FAKULTAS ILMU SOSIAL DAN ILMU
POLITIK (FISIP) UNIVERSITAS SRIWIJAYA
KOTA PALEMBANG

PERENCANA

ACRAMAD TRANDZ
NIM. 091520100008

AZAL PERMANAWAN
NIM. 091520100009

DIPERIKSA

DOSEN PEMBIMBING I

Dr. Rida Murningsih, S.T., M.T.,
NIP. 19570001198001001

DOSEN PEMBIMBING II

Sumardi Bachriah, S.T., M.T.,
NIP. 19510101960001002

JUDUL GAMBAR

DENAH BALOK DAN PELAT
LANTAI 2-5

KODE STR-01

SKALA 1 : 50

NO. GBR. JILH. GBR

01

18

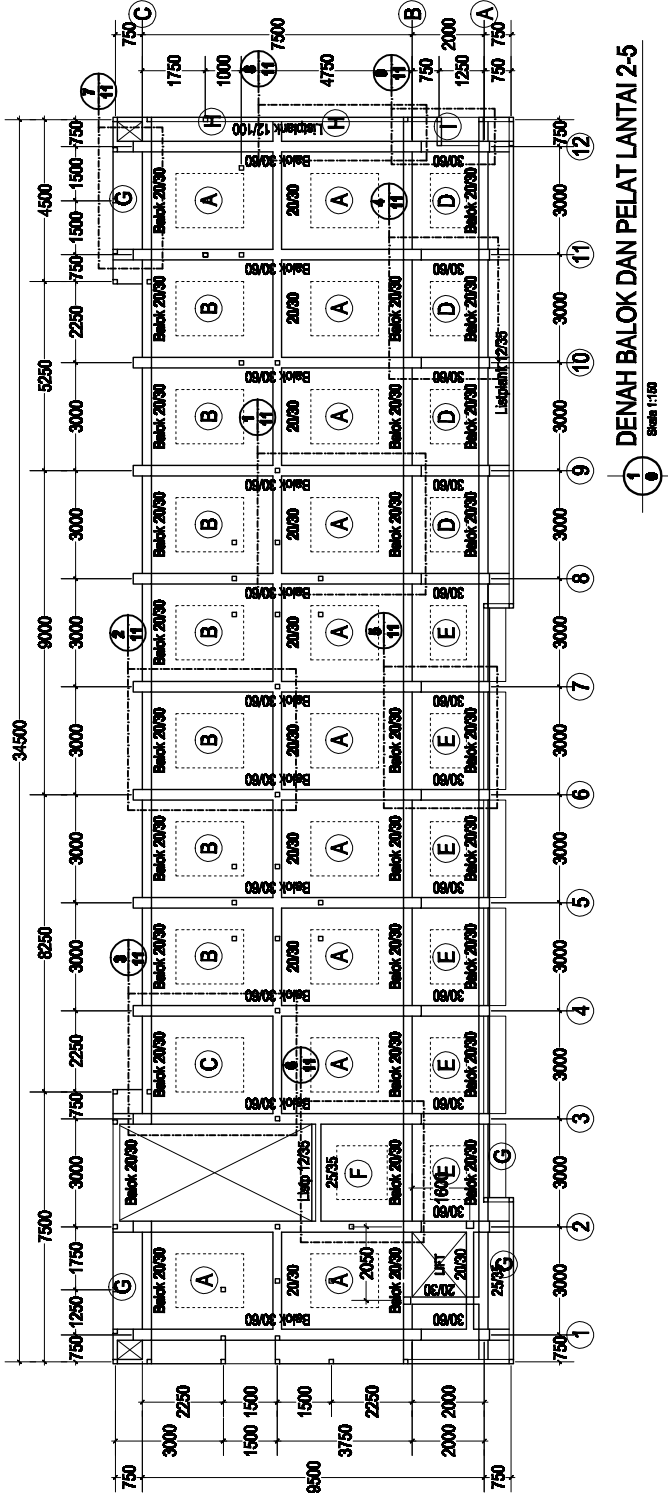

1 DENAH BALOK DAN PELAT LANTAI 2-5
Skala 1:50

CATATAN

REVISI

NO	TGL	KET.	PARAF

POLITEKNIK NEGERI SRIWIJAYA
PALEMBANG
2016



JURUSAN TEKNIK SIPIL
KONSENTRASI GEDUNG

JUDUL LAPORAN AKHIR

PERENCANAAN GEDUNG KULIAH
FAKULTAS ILMU SOSIAL DAN ILMU
POLITIK (FISIP) UNIVERSITAS SRIWIJAYA
KOTA PALEMBANG

PERENCANA

ACHMAD TRANDI Z
NIM. 091520100008

AZAL PERMANAWAN
NIM. 091520100008

DIPERIKSA

DOSEN PEMBIMBING I

Dr. Rida Murningsih, S.T., M.T.,
NIP. 19570901198001001

DOSEN PEMBIMBING II

Sumardi, S.T., M.T.,
NIP. 19510501198001002

JUDUL GAMBAR

DENAH BALOK DAN PELAT
LANTAI ATAP SIRIP

KODE STR-03

SKALA 1 : 150

NO. GBR. J. L. GBR

03

18

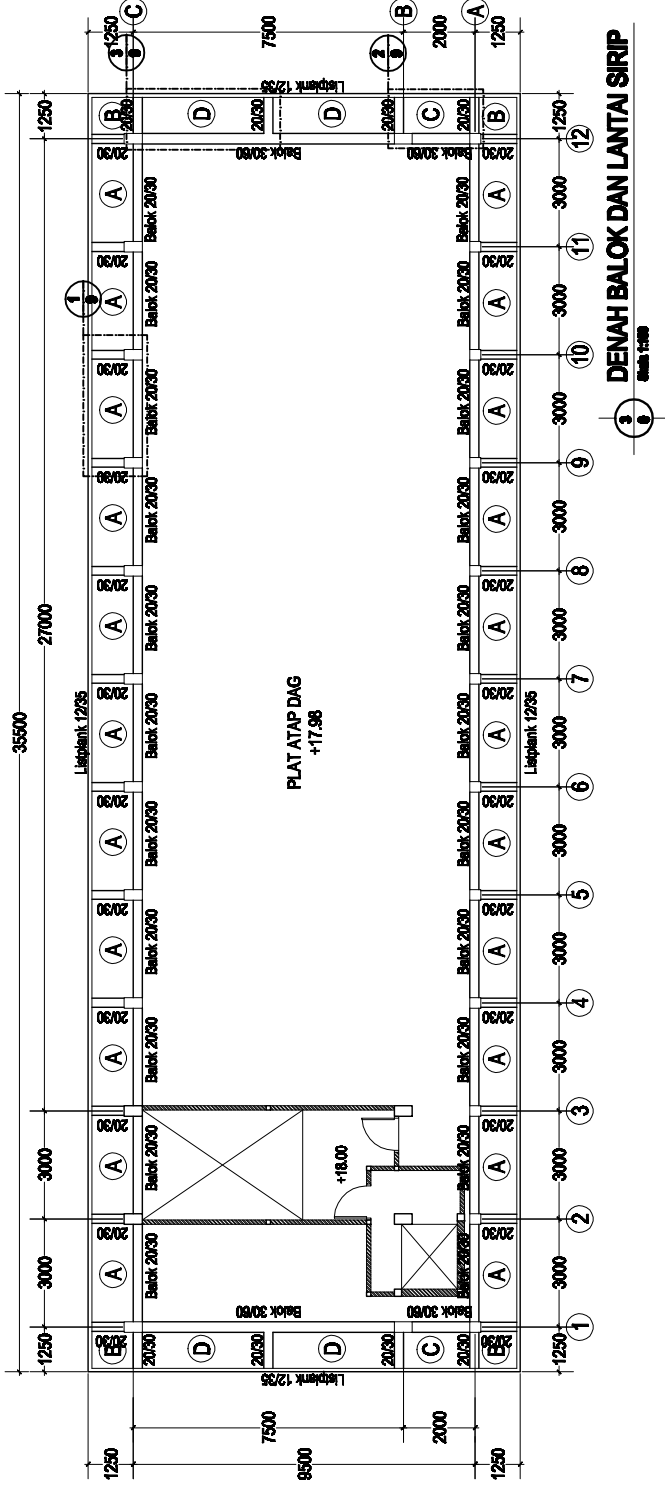

CATATAN	
REVISI	
NO	TGL
KEF.	PARAF
POLITEKNIK NEGERI SRIWIJAYA PALEMBANG 2016	
	
JURUSAN TEKNIK SIPIL KONSENTRASI GEDUNG	
JUDUL LAPORAN AKHIR	
PERENCANAAN GEDUNG KULIAH FAKULTAS ILMU SOSIAL DAN ILMU POLITIK (FISIP) UNIVERSITAS SRIWIJAYA KOTA PALEMBANG	
PERENCANA	
ACIMAD TRIANDI Z NIL. 0918010008	AZMI WIDHIYAN NIL. 0918010008
DIPERIKSA	
DOSEN PEMBIMBING I	PARAF
Dr. Rully M. S.P., M.T., NIP. 19670001198031001	
DOSEN PEMBIMBING II	PARAF
Rizkiyanti S.P., M.T., NIP. 19780101198031002	
JUDUL GAMBAR	
DETAIL BALOK INDUK ATAP SIRIP	
KODE	SKALA
STR-05	1 : 30
NO. GBR	JLH. GBR
05	18

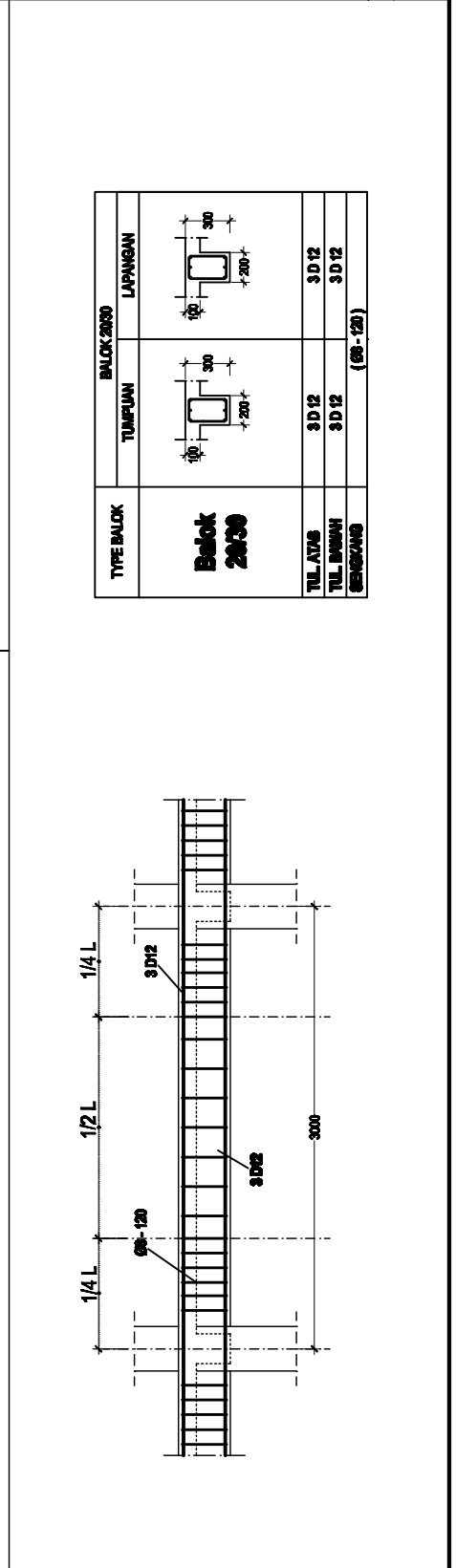
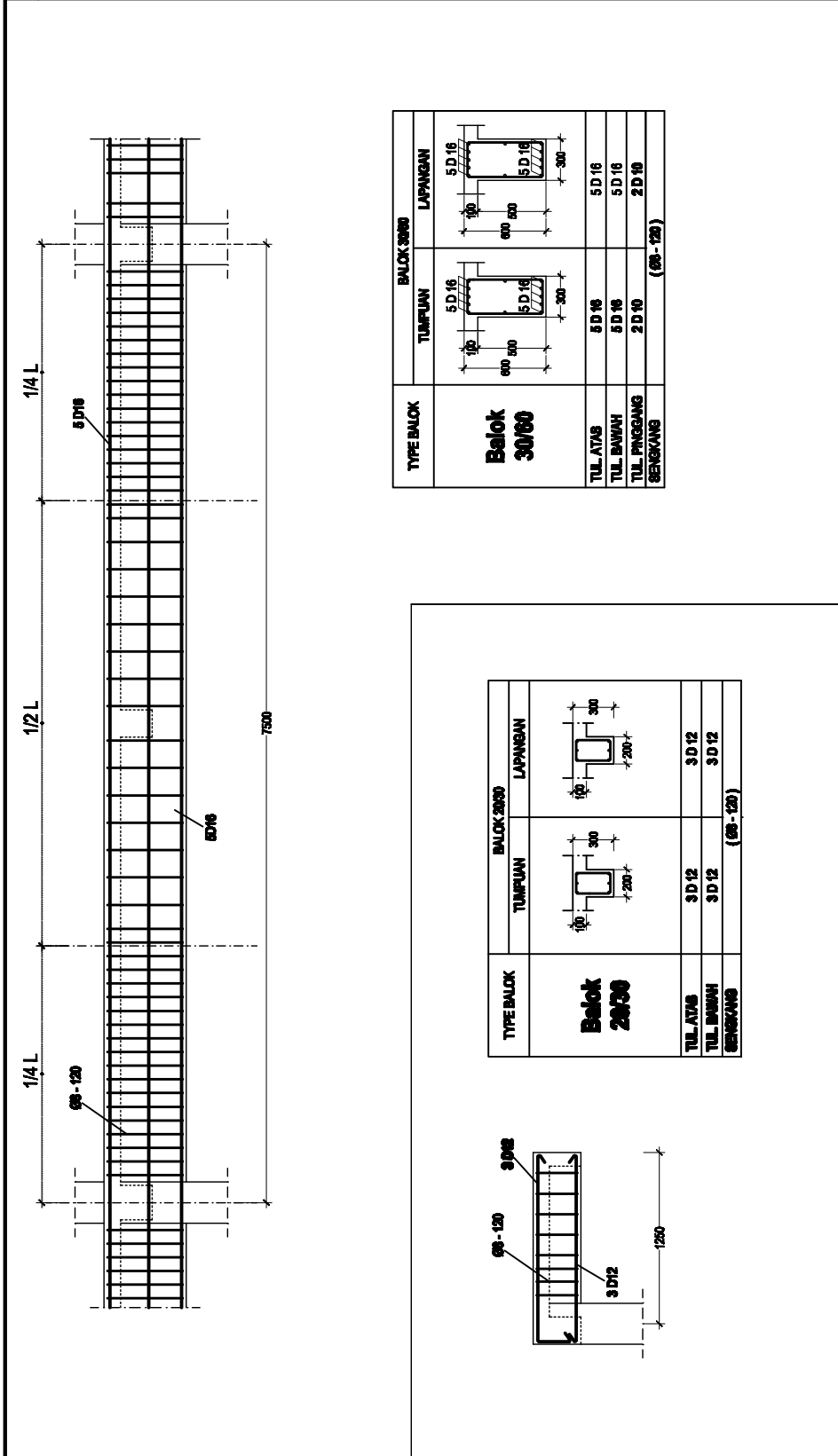

CATATAN	
REVISI	
NO	TGL
KFT.	PARAF
POLITEKNIK NEGERI SRIWIJAYA PALEMBANG 2016	
	
JURUSAN TEKNIK SIPIL KONSENTRASI GEDUNG	
JUDUL LAPORAN AKHIR	
PERENCANAAN GEDUNG KULIAH FAKULTAS ILMU SOSIAL DAN ILMU POLITIK (FISIP) UNIVERSITAS SRIWIJAYA KOTA PALEMBANG	
PERENCANA	
ACIMAD TRANDI Z NIL. 0618070008	AZMI MURDIYAN NIL. 0618070008
DIPERIKSA	
DOSEN PEMBIMBING I	PARAF
DOSEN PEMBIMBING II	PARAF
JUDUL GAMBAR	
DETAIL BALOK INDUK ATAP DAG DAN ATAP TANGGA	
KODE	SKALA
STR-06	1 : 30
NO. GBR	JLH. GBR
06	18

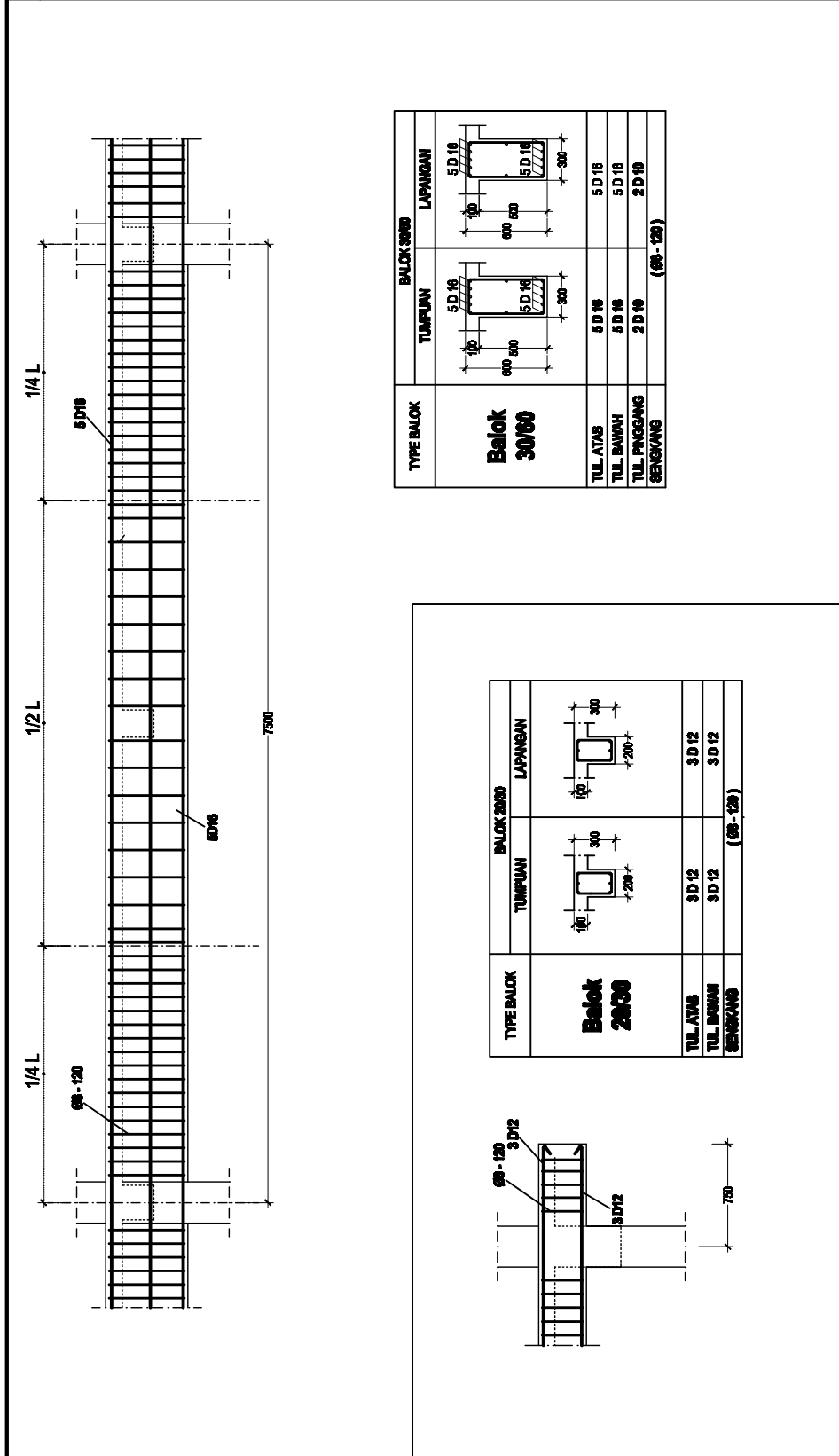

TYPE BALOK	BALOK 30/60	
	TUMPUAN	LAPANGAN
Balok 30/60		
	TUL. ATAS 5 D 16	5 D 16
	TUL. BAWAH 5 D 16	5 D 16
SENGKANG	2 D 10	2 D 10
	(88 - 120)	

TYPE BALOK	BALOK 20/30	
	TUMPUAN	LAPANGAN
Balok 20/30		
	TUL. ATAS 3 D 12	3 D 12
	TUL. BAWAH 3 D 12	3 D 12
SENGKANG	(88 - 120)	

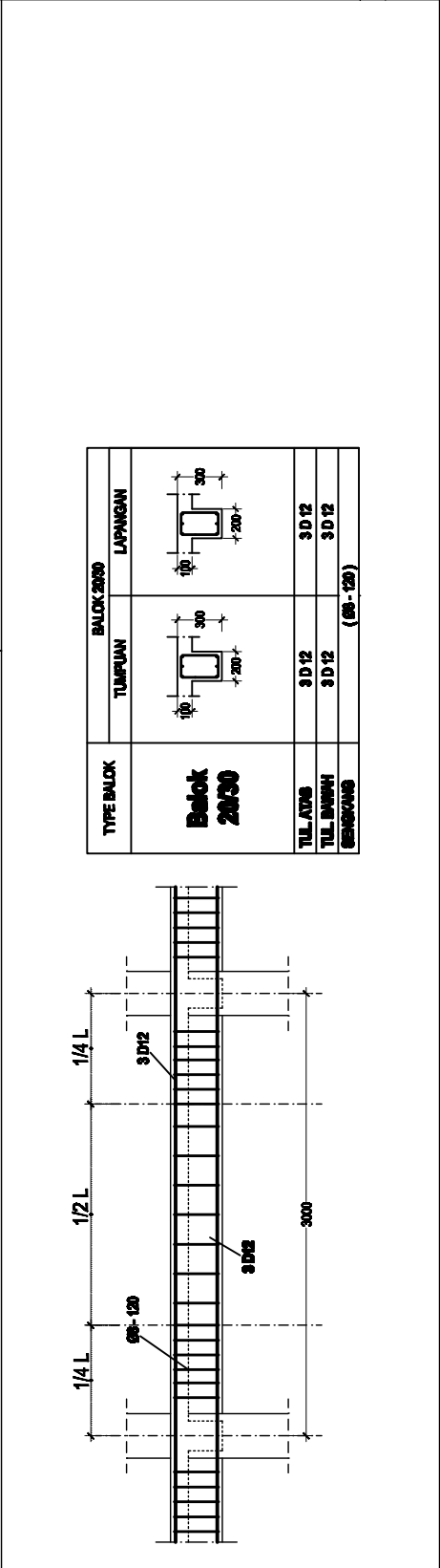
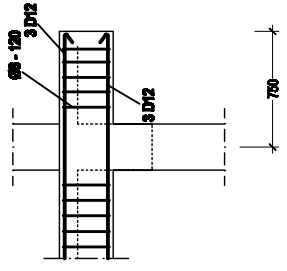

TYPE BALOK	BALOK 20/30	
	TUMPUAN	LAPANGAN
Balok 20/30		
	TUL. ATAS 3 D 12	3 D 12
	TUL. BAWAH 3 D 12	3 D 12
SENGKANG	(88 - 120)	

CATATAN	
REVISI	
NO	TGL
KEF.	PARAF
POLITEKNIK NEGERI SRIWIJAYA PALEMBANG 2016	
	
JURUSAN TEKNIK SIPIL KONSENTRASI GEDUNG	
JUDUL LAPORAN AKHIR	
PERENCANAAN GEDUNG KULIAH FAKULTAS ILMU SOSIAL DAN ILMU POLITIK (FISIP) UNIVERSITAS SRIWIJAYA KOTA PALEMBANG	
PERENCANA	
ACIMAD TRIANDI Z NIL. 0918010008	AZMI WIDHIYAN NIL. 0918010008
DIPERIKSA	
DOSEN PEMBIMBING I	PARAF
Dr. Rully M. S.P., M.T., NIP. 19670601198001001	
DOSEN PEMBIMBING II	PARAF
Rizkiyanti S.P., M.T., NIP. 19751016198001002	
JUDUL GAMBAR	
DETAIL BALOK INDUK LANTAI 2-5	
KODE	SKALA
STR-07	1 : 30
	07
	18

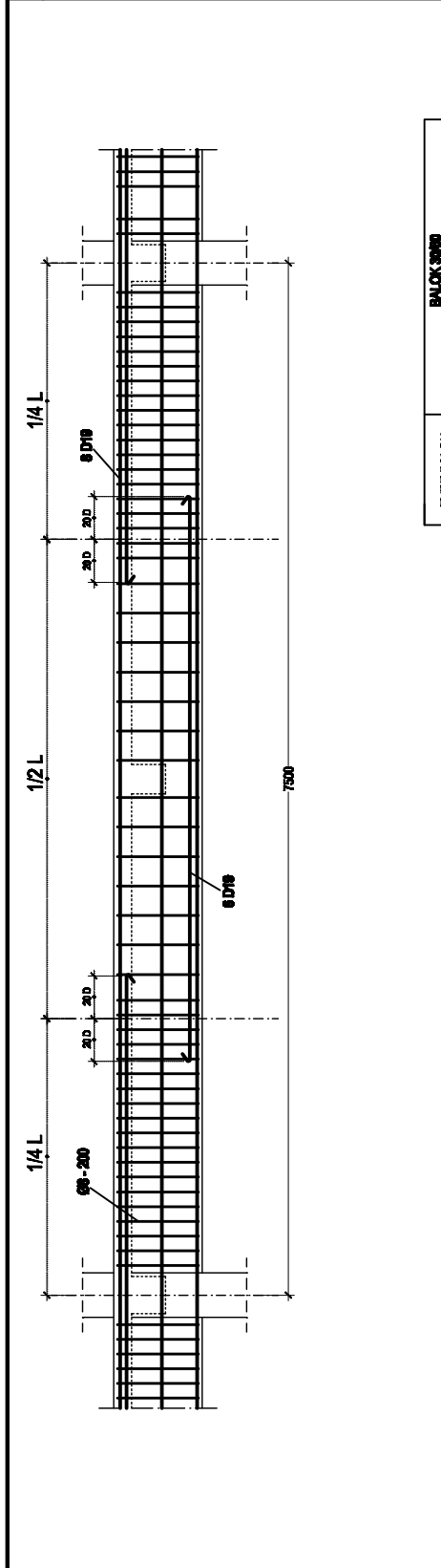

TYPE BALOK	BALOK 30/60	
	TUMPUAN	LAPANGAN
Balok 30/60		
	TUL. ATAS 8 D 19	8 D 19
	TUL. BAWAH 8 D 19	8 D 19
SEBANGKANG	2 D 10	2 D 10
	(80-200)	

TYPE BALOK	BALOK 20/30	
	TUMPUAN	LAPANGAN
Balok 20/30		
	TUL. ATAS 5 D 12	5 D 12
	TUL. BAWAH 3 D 12	3 D 12
SEBANGKANG	(80-120)	

TYPE BALOK	BALOK 20/30	
	TUMPUAN	LAPANGAN
Balok 20/30		
	TUL. ATAS 5 D 12	5 D 12
	TUL. BAWAH 3 D 12	3 D 12
SEBANGKANG	(80-120)	

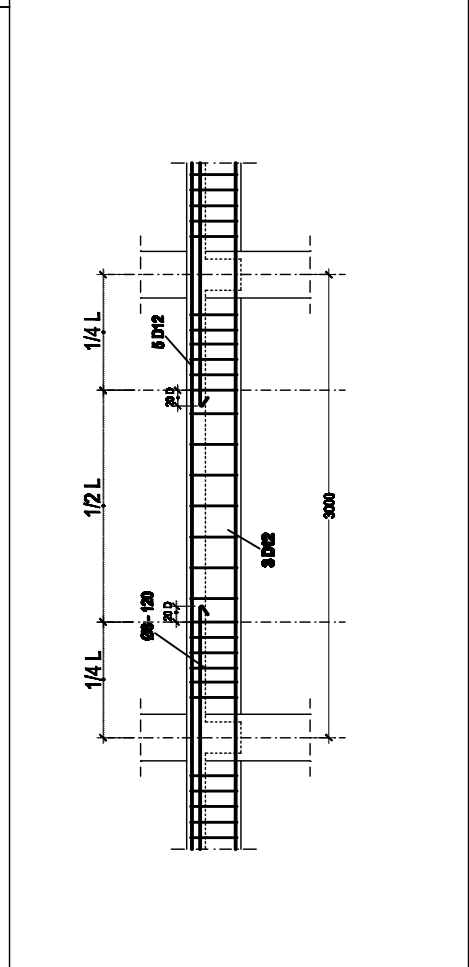

CATATAN	
REVISI	
NO	TGL
KFT.	
PARAF	
POLITEKNIK NEGERI SRIWIJAYA PALEMBANG 2016	
 JURUSAN TEKNIK SIPIL KONSENTRASI GEDUNG	
JUDUL LAPORAN AKHIR	
PERENCANAAN GEDUNG KULIAH FAKULTAS ILMU SOSIAL DAN ILMU POLITIK (FISIP) UNIVERSITAS SRIWIJAYA KOTA PALEMBANG	
PERENCANA	
ACIMAD TRIANDI Z NIL. 0918010008	AZMI WIDHIYAN NIL. 0918010008
DIPERIKSA	
DOSEN PEMBIMBING I	PARAF
Dr. Rini Mulyanti, S.T., M.T., NIP. 19670001980031001	
DOSEN PEMBIMBING II	PARAF
Sumarta, S.T., M.T., NIP. 1965161980031002	
JUDUL GAMBAR	
DETAIL BALOK ANAK ATAP DAN LANTAI	
KODE	SKALA
STR-08	1 : 30
NO. GBR	JL. GBR
08	18

TYPE BALOK	BALOK 20/30	
	TUMPUAN	LAPANGAN
Balok 20/30		
	TUL. ATAS 3 D 12	3 D 12
	TUL. BAWAH 3 D 12	3 D 12
SEBESKANG	(80 - 120)	

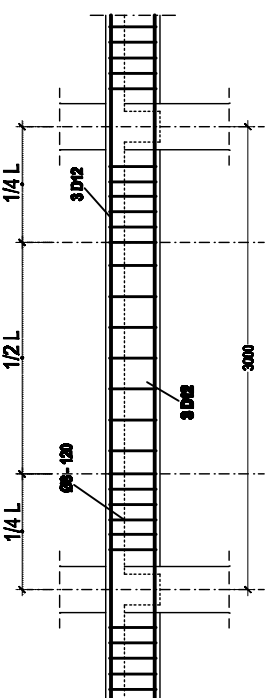

TYPE BALOK	BALOK 20/30	
	TUMPUAN	LAPANGAN
Balok 20/30		
	TUL. ATAS 5 D 12	5 D 12
	TUL. BAWAH 3 D 12	3 D 12
SEBESKANG	(80 - 120)	

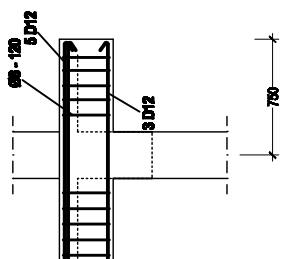

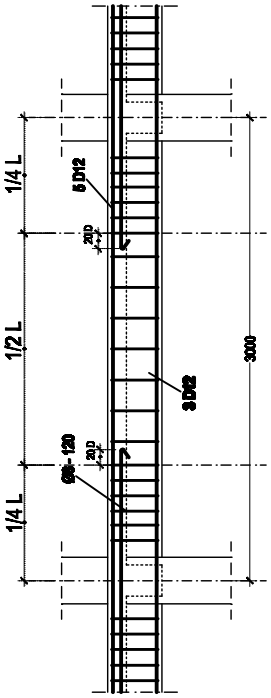
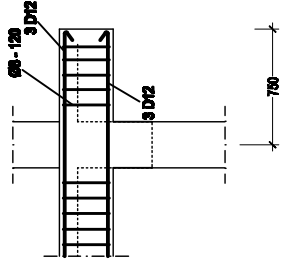

TYPE BALOK	BALOK 20/30	
	TUMPUAN	LAPANGAN
Balok 20/30		
	TUL. ATAS 3 D 12	3 D 12
	TUL. BAWAH 3 D 12	3 D 12
SEBESKANG	(80 - 120)	

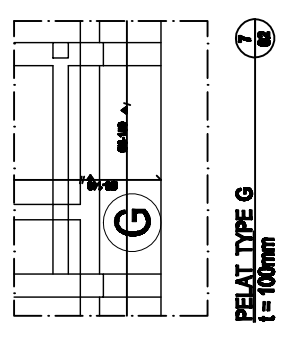
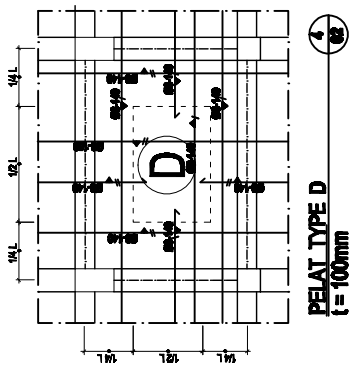
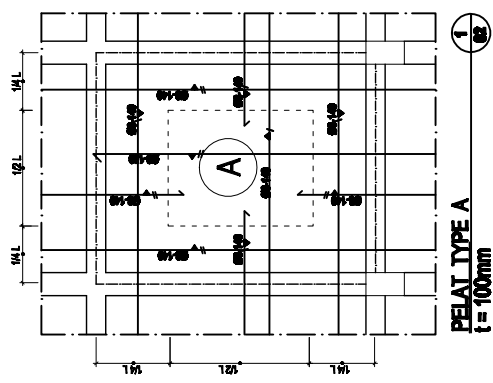
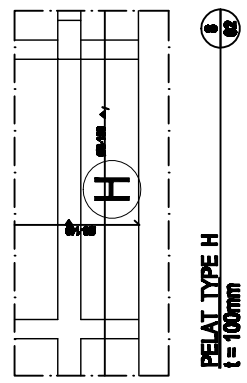
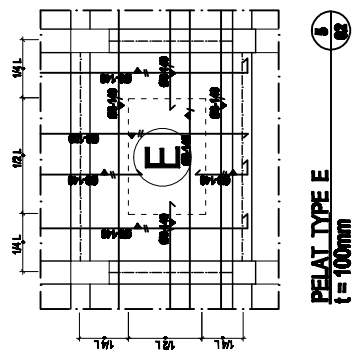
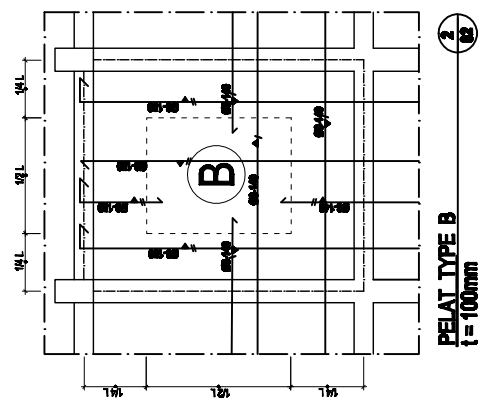
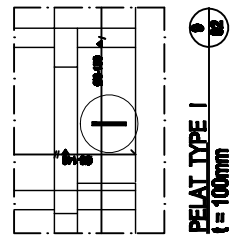
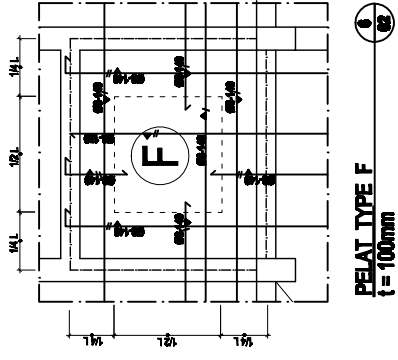
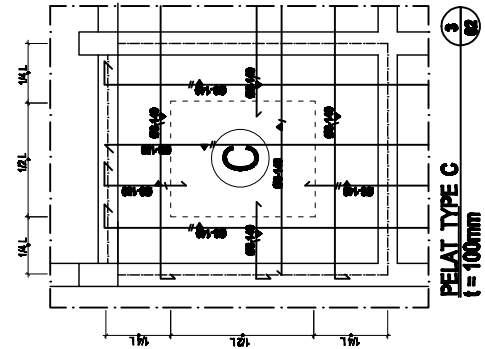

TYPE BALOK	BALOK 20/30	
	TUMPUAN	LAPANGAN
Balok 20/30		
	TUL. ATAS 5 D 12	5 D 12
	TUL. BAWAH 3 D 12	3 D 12
SEBESKANG	(80 - 120)	

CATATAN			
REVISI			
NO TGL	KET. PARAF		
POLITEKNIK NEGERI SRIWIJAYA PALEMBANG 2016			
			
JURUSAN TEKNIK SIPIL KONSENTRASI GEDUNG JUDUL LAPORAN AKHIR PERENCANAAN GEDUNG KULIAH FAKULTAS ILMU SOSIAL DAN ILMU POLITIK (FISIP) UNIVERSITAS SRIWIJAYA KOTA PALEMBANG			
PERENCANA			
ACIMAD TRIANDU NIM. 0918010008	AZMI MURMAYAN NIM. 0918010009		
DIPERIKSA			
DOSEN PEMBIMBING I	PARAF		
Dr. H. M. ... NIP. 19570001980001001			
DOSEN PEMBIMBING II	PARAF		
JUDUL GAMBAR			
DETAIL PENULANGAN PELAT ATAP DAG			
KODE	SKALA	NO. GBR	JLH. GBR
STR-10	1 : 25	10	18



CATATAN	
REVISI	
NO	TGL. KET. PARAF
POLITEKNIK NEGERI SRIWIJAYA PALEMBANG 2016	
	
JURUSAN TEKNIK SIPIL KONSENTRASI GEDUNG	
JUDUL LAPORAN AKHIR	
PERENCANAAN GEDUNG KULIAH FAKULTAS ILMU SOSIAL DAN ILMU POLITIK (FISIP) UNIVERSITAS SRIWIJAYA KOTA PALEMBANG	
PERENCANA	
ACIMAD TRIANDI Z NIM. 0918010008	AZMI NIRMAYAN NIM. 0918010009
DIPERIKSA	
DOSEN PEMBIMBING I Drs. H. M. ... S.T., M.T., NIP. 19570001980001001	PARAF
DOSEN PEMBIMBING II Syaiful Hudaq, S.T., M.T., NIP. 19701010198001002	PARAF
JUDUL GAMBAR	
DETAIL PENULANGAN PELAT LANTAI 2-5	
KODE	SKALA NO. GBR/JL.H. GBR
STR-11	1 : 25 11 18

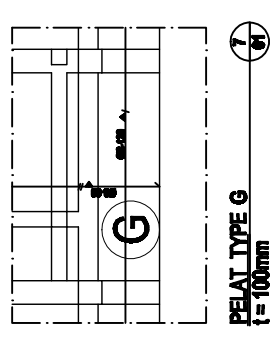
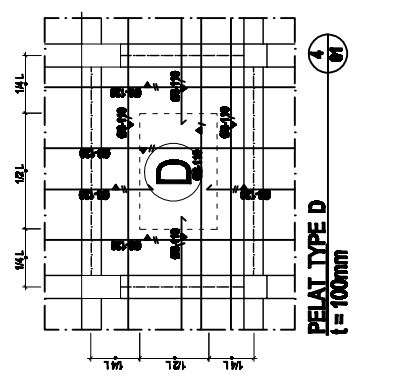
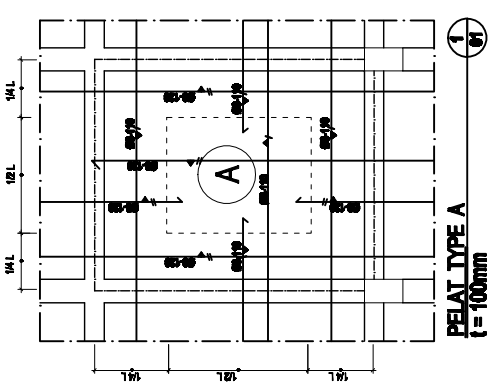
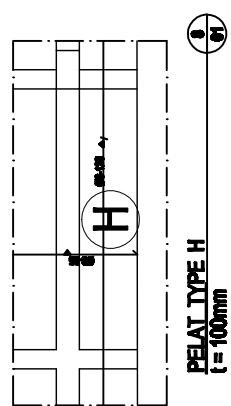
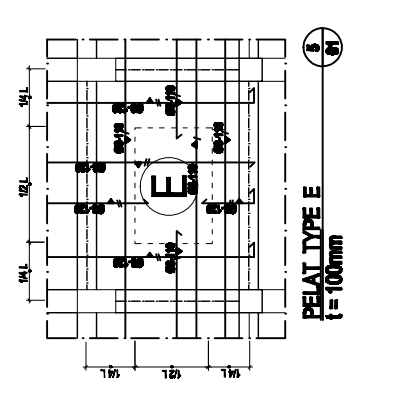
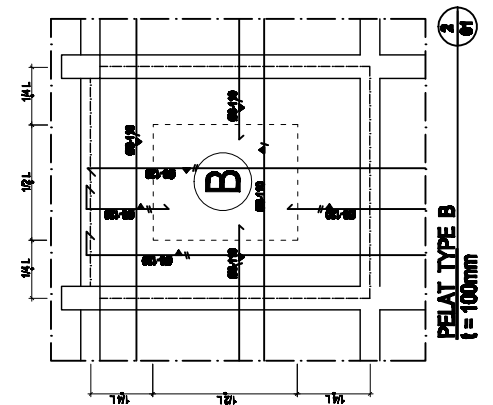
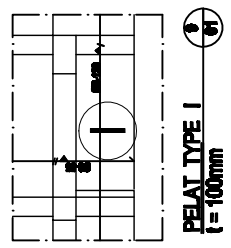
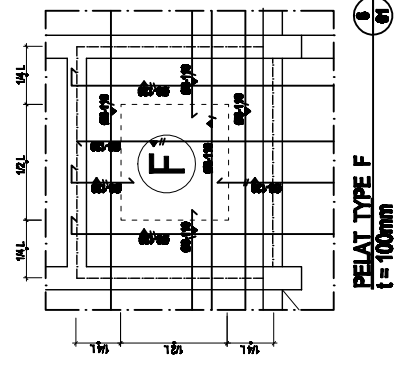
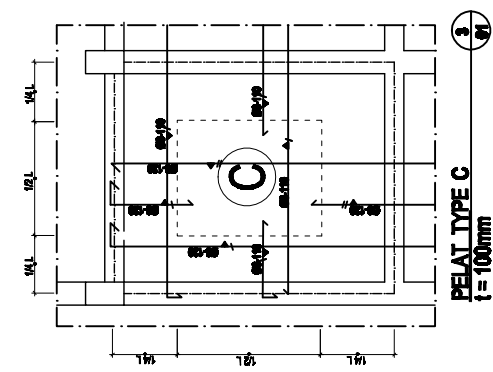

CATATAN

REVISI

NO	TGL	KET.	PARAF

POLITEKNIK NEGERI SRIWIJAYA
PALEMBANG
2016



JURUSAN TEKNIK SIPIL
KONSENTRASI GEDUNG

JUDUL LAPORAN AKHIR

PERENCANAAN GEDUNG KULIAH
FAKULTAS ILMU SOSIAL DAN ILMU
POLITEK (FISIP) UNIVERSITAS SRIWIJAYA
KOTA PALEMBANG

PERENCANA

ACRAMAD TRANDIZ
NIM. 091520140028

AZALI PERMANAWAN
NIM. 091520140030

DIPERIKSA

DOSEN PEMBIMBING I
Drs. Rudi Murningsih, S.T., M.T.,
NIP. 19570001198001001

DOSEN PEMBIMBING II
Samsul Bahri, S.T., M.T.,
NIP. 19510101198001002

JUDUL GAMBAR

DENAH KOLOM STRUKTUR

KODE	SKALA	NO. GBR	JLH. GBR
STR-13	1 : 150	13	18

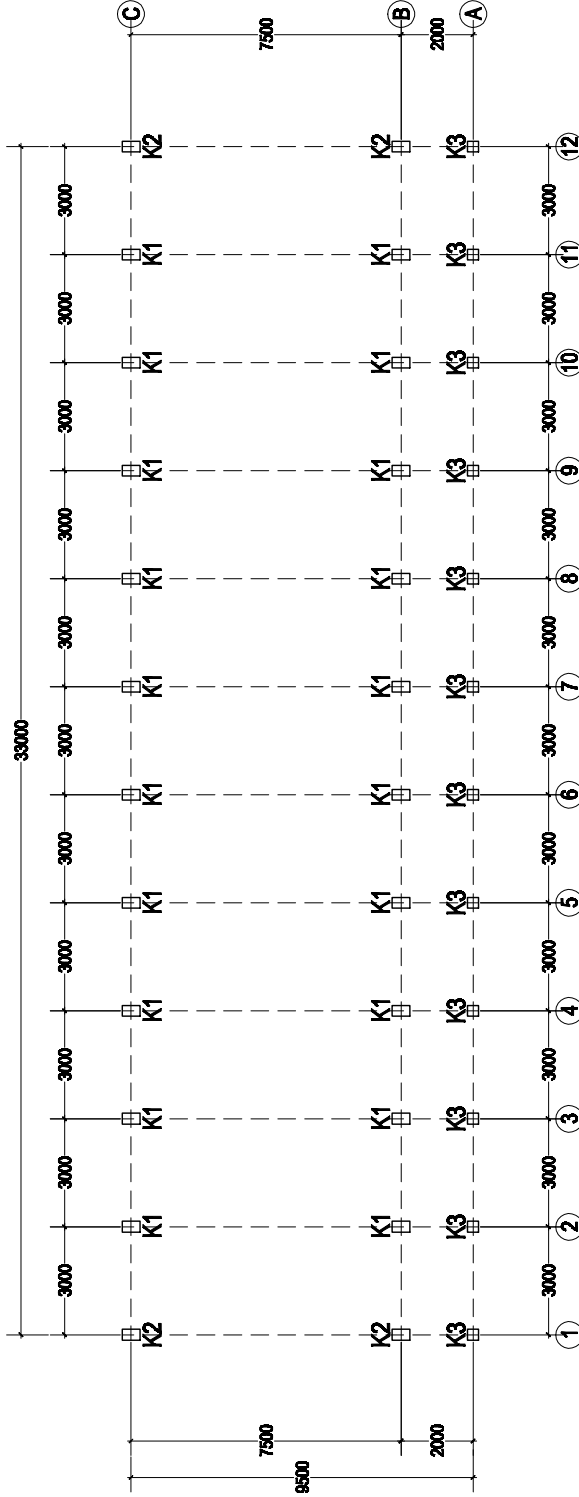

DENAH KOLOM STRUKTUR LT. 1-5

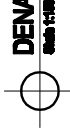

CATATAN		
REVISI		
NO	TGL	KRT. PARAF
POLITEKNIK NEGERI SRIWIJAYA PALEMBANG 2016		
 JURUSAN TEKNIK SIPIL KONSENTRASI GEDUNG		
JUDUL LAPORAN AKHIR		
PERENCANAAN GEDUNG KULIAH FAKULTAS ILMU SOSIAL DAN ILMU POLITIK (FISIP) UNIVERSITAS SRIWIJAYA KOTA PALEMBANG		
PERENCANA		
ACIMAD TRIANDI Z NIL. 0918010008	AZMI WIDHIYAN NIL. 0918010009	
DIPERIKSA		
DOSEN PEMBIMBING I Dip. Diah Mulyaningrum, S.T., M.T., NIP. 19670601196001001	PARAF	
DOSEN PEMBIMBING II Samsul Hudaib, S.T., M.T., NIP. 19610616196001002	PARAF	
JUDUL GAMBAR		
DETAIL KOLOM K1-K2-K3		
KODE	SKALA	NO. GBR/JLH. GBR
STR-14	1 : 25	14 18

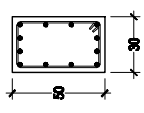
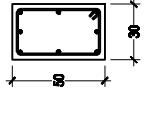
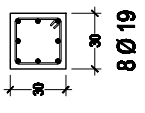
<p>A. Tg (+ 20.50)</p> <p>Atap (+ 18.00)</p> <p>LT - 5 (+ 14.40)</p> <p>LT - 4 (+ 10.80)</p> <p>LT - 3 (+ 7.20)</p> <p>LT - 2 (+ 3.60)</p> <p>LT - 1 (± 0.00)</p> <p>PONDASI</p>  <p>12 Ø 19</p>	<p>A. Tg (+ 20.50)</p> <p>Atap (+ 18.00)</p> <p>LT - 5 (+ 14.40)</p> <p>LT - 4 (+ 10.80)</p> <p>LT - 3 (+ 7.20)</p> <p>LT - 2 (+ 3.60)</p> <p>LT - 1 (± 0.00)</p> <p>PONDASI</p>  <p>8 Ø 19</p>	<p>A. Tg (+ 20.50)</p> <p>Atap (+ 18.00)</p> <p>LT - 5 (+ 14.40)</p> <p>LT - 4 (+ 10.80)</p> <p>LT - 3 (+ 7.20)</p> <p>LT - 2 (+ 3.60)</p> <p>LT - 1 (± 0.00)</p> <p>PONDASI</p>  <p>8 Ø 19</p>	
SENGKANG	D 8 - 200	D 8 - 200	Ø 8 - 200
POSISI	TUMPUAN	LAPANGAN	TUMPUAN
TYPE	K - 1	K - 2	K - 3

DETAIL KOLOM K1-K2-K3

CATATAN	
REVISI	
NO	TGL
KRT.	PARAF
POLITEKNIK NEGERI SRIWIJAYA PALEMBANG 2016	
 JURUSAN TEKNIK SIPIL KONSENTRASI GEDUNG	
JUDUL LAPORAN AKHIR	
PERENCANAAN GEDUNG KULIAH FAKULTAS ILMU SOSIAL DAN ILMU POLITIK (FISIP) UNIVERSITAS SRIWIJAYA KOTA PALERANG	
PERENCANA	
ACRAMAD TRANDIZ NIM. 091520100208	AZAL PERAWAN NIM. 091520100208
DIPERIKSA	
DOSEN PEMBIMBING I	PARAF
Dr. Rida Murningsih, S.T., M.T., NIP. 19570901198001001	
DOSEN PEMBIMBING II	PARAF
Sumardi, S.T., M.T., NIP. 19540901198001002	
JUDUL GAMBAR	
DENAH SLOOF DAN DETAIL SLOOF	
KODE	SKALA
STR-15	NO. GBR/JLH. GBR
	15
	18

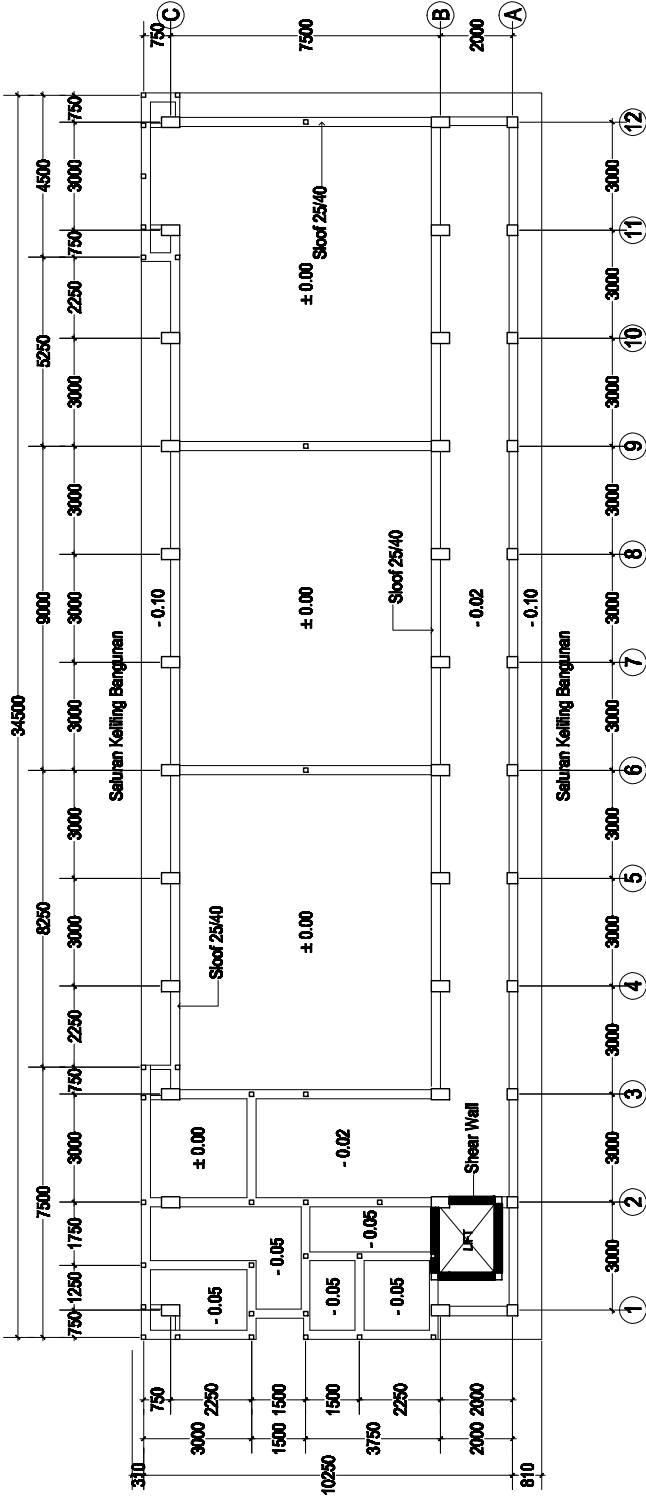

DENAH SLOOF DAN PONDASI BATU BATA
Skala 1:200

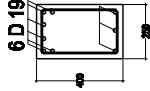
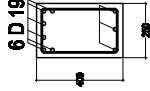
TYPE BALOK	SLOOF 25/40 ARAH MELINTANG	
	TUMPUAN	LAPANGAN
SLOOF 25/40		
	TUL. ATAS	6 D 19
	TUL. BAWAH	3 D 19
SENGKANG	(68 - 100)	

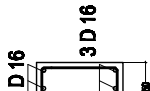
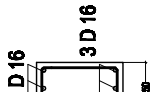
TYPE BALOK	SLOOF 25/40 ARAH MEMANJANG	
	TUMPUAN	LAPANGAN
SLOOF 25/40		
	TUL. ATAS	3 D 16
	TUL. BAWAH	3 D 16
SENGKANG	(68 - 100)	

CATATAN

REVISI

NO	TGL	KET.	PARAF

POLITEKNIK NEGERI SRIWIJAYA
PALEMBANG
2016



JURUSAN TEKNIK SIPIL
KONSENTRASI GEDUNG

JUDUL LAPORAN AKHIR

PERENCANAAN GEDUNG KULIAH
FAKULTAS ILMU SOSIAL DAN ILMU
POLITIK (FISIP) UNIVERSITAS SRIWIJAYA
KOTA PALEMBANG

PERENCANA

ACHMAD TRANDZ
NIM. 09152010028

AZAL PERAWAN
NIM. 09152010030

DIPERIKSA

DOSEN PEMBIMBING I

Dr. Rida Murningsih, S.T., M.T.,
NIP. 19570901198001001

DOSEN PEMBIMBING II

Sumardi, S.T., M.T.,
NIP. 19540501198001002

JUDUL GAMBAR

DENAH PILECAP

KODE STR-16

SKALA 1 : 100

NO. GBR.11.1. GBR

16

18

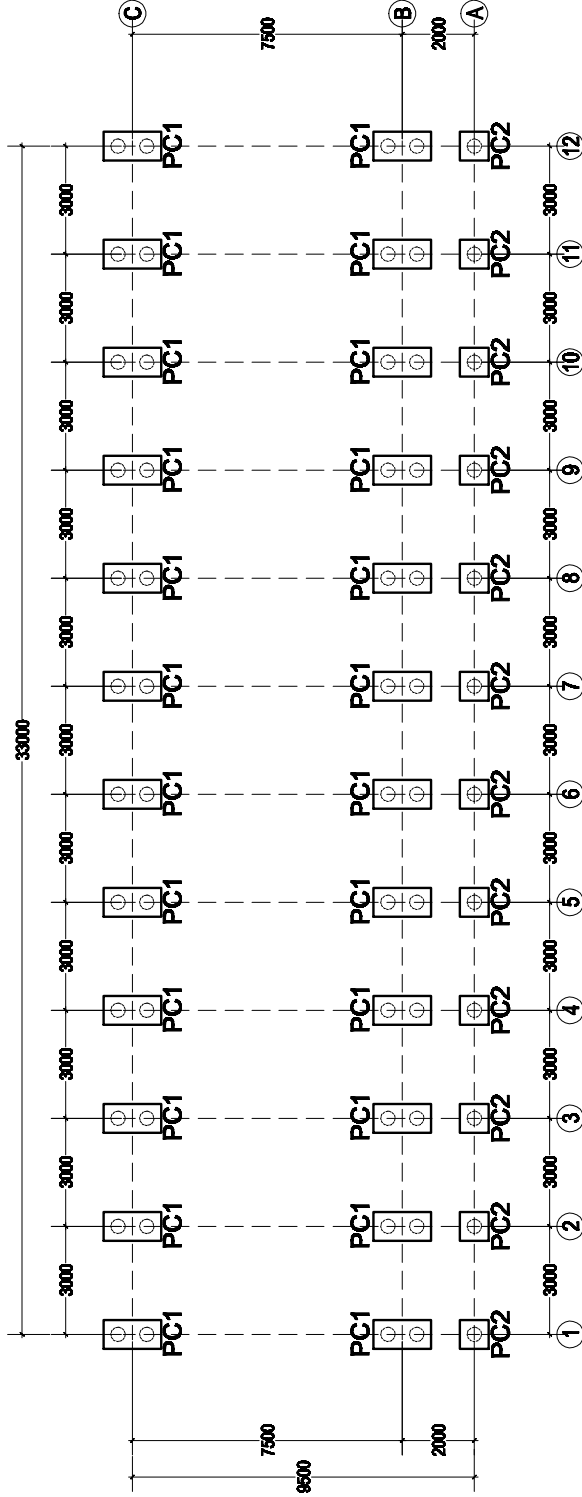

DENAH PILECAP

Skala 1:100

CATATAN

REVISI

NO	TGL	KET.	PARAF

POLITEKNIK NEGERI SRIWIJAYA
PALEMBANG
2016



JURUSAN TEKNIK SIPIL
KONSENTRASI GEDUNG

JUDUL LAPORAN AKHIR

PERENCANAAN GEDUNG KULIAH
FAKULTAS ILMU SOSIAL DAN ILMU
POLITIK (FISIP) UNIVERSITAS SRIWIJAYA
KOTA PALERANG

PERENCANA

ACHMAD TRANDY Z
NIM. 001220100208

AZAL PERMANAWAN
NIM. 001220100208

DIPERIKSA

DOSEN PEMBIMBING I

Dr. Rida Murningsih, S.T., M.T.,
NIP. 19570901198001001

DOSEN PEMBIMBING II

Sumardi, S.T., M.T.,
NIP. 19540501198001002

JUDUL GAMBAR

DENAH BORED PILE

KODE	SKALA	NO. GBR	JLH. GBR
STR-17	1 : 100	17	18

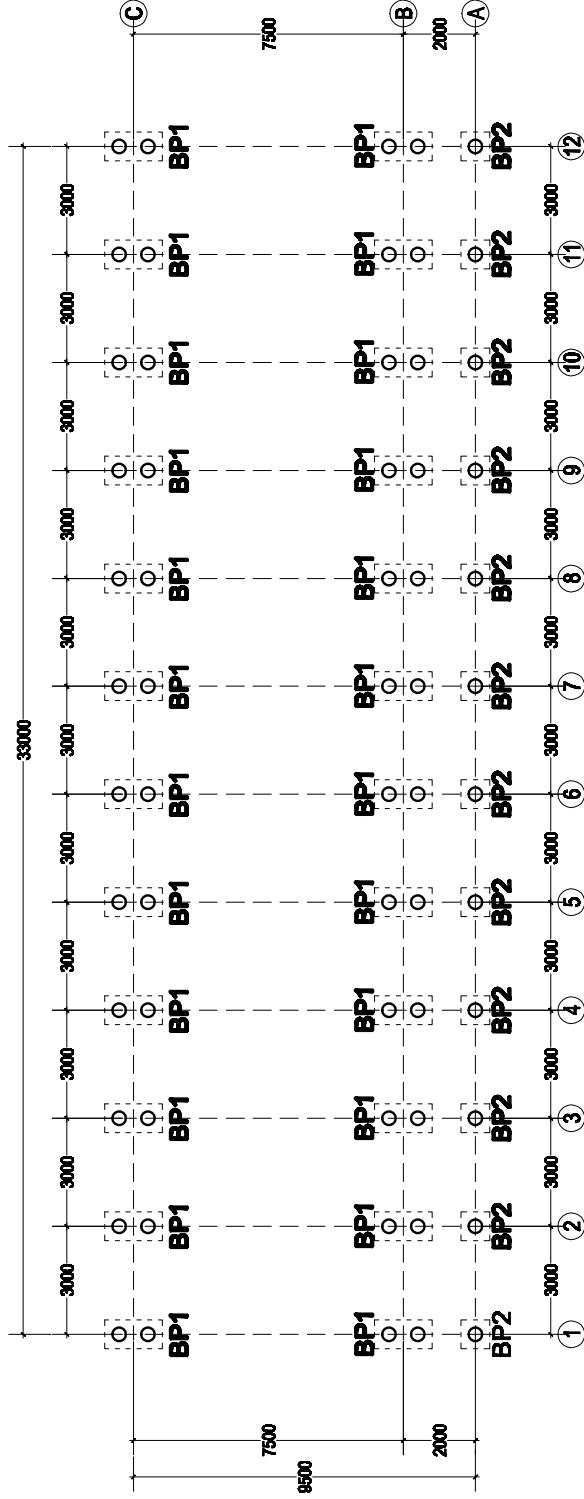

DENAH BORED PILE
Scale 1:100

CATATAN	
REVIZI	
NO	TGL.
	KRT.
	PARAF
POLITEKNIK NIGERI SURABAYA PALEMBANG 2016	
 JURUSAN TEKNIK SIPIL KONSENTRASI GEDUNG	
JUDUL LAPORAN AKHIR	
PERENCANAAN GEDUNG KULIAH FAKULTAS ILMU SOSIAL DAN ILMU POLITIK (FESIP) UNIVERSITAS SURABAYA KOTA PALEMBANG	
PERENCANA	
ACARA JAWAB	AKHIR
DIPERIKSA	
DOSEN PEMBIMBING I	PARAF
DOSEN PEMBIMBING II	PARAF
JUDUL GAMBAR	
DETAIL FONDASI P1 DAN P2	
KODE	SKALA
STR-18	1 : 25
	NO. GBR/JLH. GBR
	18
	18

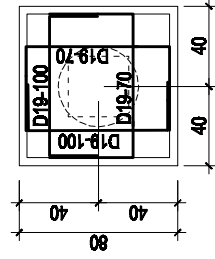
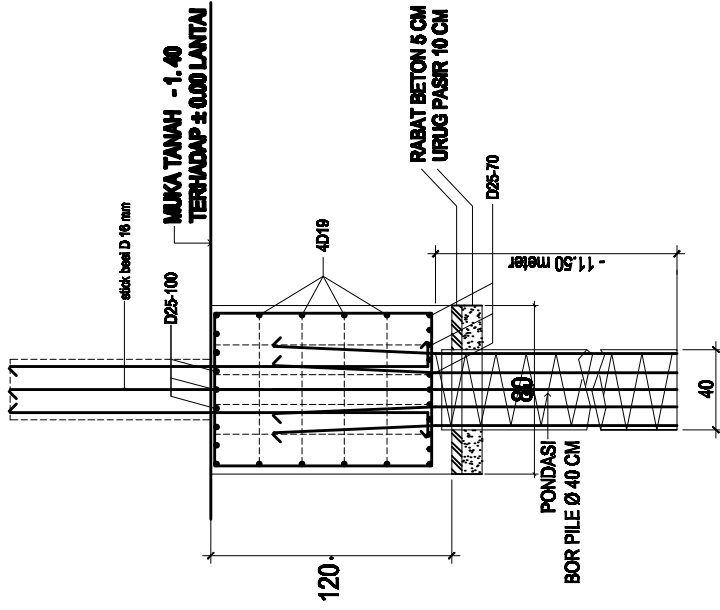

DETAIL P-2 (12 UNIT)
Skala 1 : 25

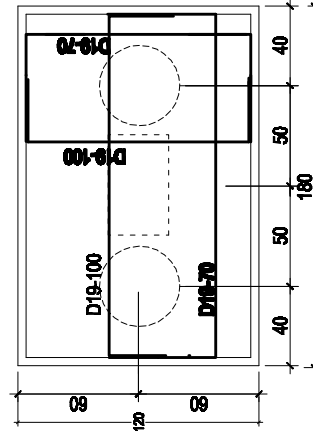
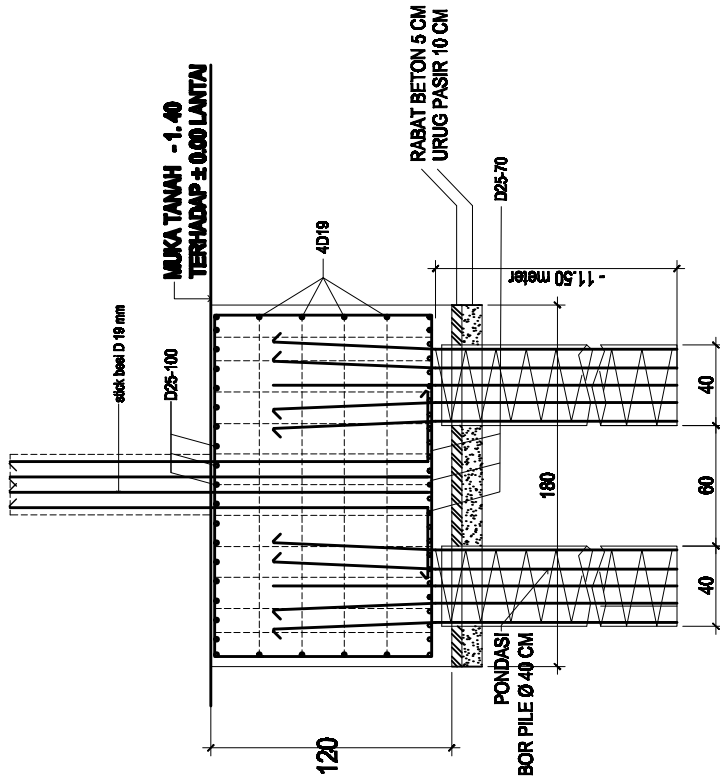

DETAIL P-1 (24 UNIT)
Skala 1 : 25